

2006-1H2005

Commercial Air Conditioners 2020



Air Source Heat Pump Water Heater



Commercial Air Conditioner Division Midea Group

Add.: Midea Headquarters Building, 6 Midea Avenue, Shunde, Foshan, Guangdong, China

Postal code: 528311

cac.midea.com www.midea-group.com



Note: Product specifications change from time to time as product improvements and developments are released and may vary from those in this document.

GD MIDEA Heating & Ventilating Equipment Co. Ltd participates in the ECP programme for LCP-HP. Check ongoing validity of certificate: WWW.eurovent-certification.com



Midea CAC

Midea CAC is a key division of the Midea Group, a leading producer of consumer appliances and provider of heating, ventilation and air conditioning solutions. Midea CAC has continued with the tradition of innovation upon which it was founded, and emerged as a global leader in the HVAC industry. A strong drive for advancement has created a groundbreaking R&D department that has placed Midea CAC at the forefront of a competitive field. Through these independent efforts and joint cooperation with other global enterprises, Midea has supplied thousands of innovative solutions to customers worldwide.

There are four production bases: Shunde, Chongqing, Hefei and Italy.

MCAC Shunde: 38 product lines focusing on VRF, Split Products, Heat Pump Water Heaters, and AHU/FCU.

MCAC Chongqing: 14 product lines focusing on Water Cooled Centrifugal/Screw/Scroll Chillers, Air Cooled Screw/Scroll Chillers and AHU/FCU.

MCAC Hefei: 11 product lines focusing on VRF, Chillers and Heat Pump Water Heaters.

Clivet S.p.A: 50,000m² workshop in Feltre and Verona, covering products such as ELFO system, hydronic, WHLP, packaged, split and close control and so on.

- 2020 >> Launched the 4th generation of R32 M-Thermal products, including Mono and Split type.
- 2018-2019 >> Launched the 3rd generation of R32 M-Thermal products, including Mono and Split type.
- 2016 >> Acquired 80% stake in Clivet
 - Launched the 2nd generation of R410A M-Thermal products, including Mono and Split type.
- 2015 >> JV with Carrier in China in chiller field, BOSCH in VRF production and Siix in smart control.
- 2013 >> Launched combo type 300L products with enamel water tank.
- 2012 >> Introduced the professional production line EISENMAN from German.
- 2011 >> Launched the 1st generation of M-thermal products.
- 2010 >> Built the 3rd manufacturing base in Hefei.
- 2008 >> Launch the first generation of combo type products.
- 2007 >> Cooperated with GE to develop combo type air source heat pump.
- 2004 >> Launch the first generation of direct heating products.
- 2003 >> Entered the air source heat pump field and launched the first generation cycle heating products.
- 1999 >> Entered the CAC field.

MCAC Learning Academy



Objective

Midea CAC Learning Academy aims to provide training to the sales personnel as well as technical personnel in order to increase the utilization for your Midea CAC equipment. Once you have purchased equipment from Midea CAC, taking care of the equipment is topmost priority. Midea CAC Learning Academy offers training courses to learn firsthand from the manufacturer what it takes to get the best out of your Midea CAC product. The goal of Midea CAC Learning Academy is to provide product specific training, safe work procedures and expertise in carrying out the installation and maintenance of Midea CAC products as well as teaching the main selling points in order to help the sales people sell the Midea CAC products with ease.

Training Centers

Our world class training centers provide knowledge and skills necessary to efficiently deploy Midea CAC technologies. The training centers include dedicated laboratories to provide hands-on experiences with various systems, components and controls to refresh and enhance the skills of your sales, design and installation and service teams. Right now we operate our trainings from the below two locations:

1. Midea CAC Training Center

Address: Midea CAC Training Center, 2nd Floor, Building 6, Midea Global Innovation Center, Beijiao, Shunde, Foshan, China
Pin- 528311

The Midea CAC Training Center is situated 70 kilometers from Baiyun Guangzhou International Airport.

Products: VRF, M-Thermal

2. Chongqing Midea Training Center

Address: No. 15, Qiangwei Road, Nan'an District, Chongqing, China

Chongqing Midea Training Center is 35 kilometers from Chongqing International Airport.

Products: Centrifugal Chiller, Screw/Scroll Chiller and Terminals



VRF training

M-Thermal training

Chiller training

Global Technical Trainings

The training courses by Midea CAC Learning Academy are divided into the following two categories with different targeted audiences for each.

Design and Application Trainings: The design and application trainings for various products are basically for the sales personnel selling Midea CAC products in order to give them basic understanding about the main features. The trainings are conducted on a global level inviting sales engineers, technical engineers, consultants and project designers from different parts of the world.

Main Courses Offered:

1. Introduction to main Selling points and Features
2. Installation and Commissioning
3. Control Systems
4. Selection Software



Products: VRF, M-Thermal, Chillers and Terminals

After Sales- Service Trainings: These trainings are dedicated for the After Sales/ Service personnel in order for them to better carry out the installation, commissioning and maintenance of Midea CAC products. Technical person and engineers from different parts of the world are invited to take part in these trainings.

Main Courses Offered:

1. Product Electric Control and Refrigerant System
2. Control Systems
3. Installation and Commissioning Demonstration
4. Troubleshooting and Maintenance

Products: VRF, M-Thermal, Chillers and Terminals

Highly Skilled Trainers: The trainers for various courses by Midea CAC Learning Academy are expert people with vast experiences in their field. Most of them have a deep insight about the global HVAC market and help the attendees to better understand the CAC products.

Training Certificates:

The attendees for Global trainings are provided a training certificate highlighting the courses discussed in the training, signed by Mr. Jason Zhao, General Manager of Midea CAC Overseas Sales Company.

Registration:

You can contact your respective Midea contact point to provide you with the complete schedule about the global technical trainings as well as how to register for these trainings.



Reference projects



Aston Kuta Bali Hotel (Five Star)

Country: Indonesia
 City: Bali
 Completion Year: 2010

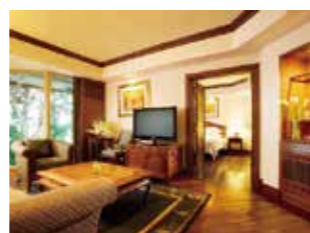

Sheraton Bandara Resort Hotel (Five Star)

Country: Indonesia
 City: Jakarta
 Completion Year: 2011



Ramada Plaza (Five Star)

Country: China
 City: Shunde
 Completion Year: 2009



The Royale Springhill Residences

Country: Indonesia
 City: Jakarta
 Completion Year: 2010



Grand Aston Tunjungan (Five Star)

Country: Indonesia
 City: Surabaya
 Completion Year: 2013

Contents

13 M thermal



42 Sanitary Hot Water



49 Swimming Pool Application



53 Commercial Heat Pump Water Heater



Agile Estate (Clear Water Bay)

Country: China
 City: Sanya
 Completion Year: 2011



Shanghai Fudan University (Dormitory Building)

Country: China
 City: Shanghai

Introduction

Why choose an air source heat pump?



Typically around 3kWh of energy can be captured for every 1kWh of electrical energy expended, giving almost 4kWh of heat energy for only 1kWh of electrical input and giving efficiency of almost 400%.

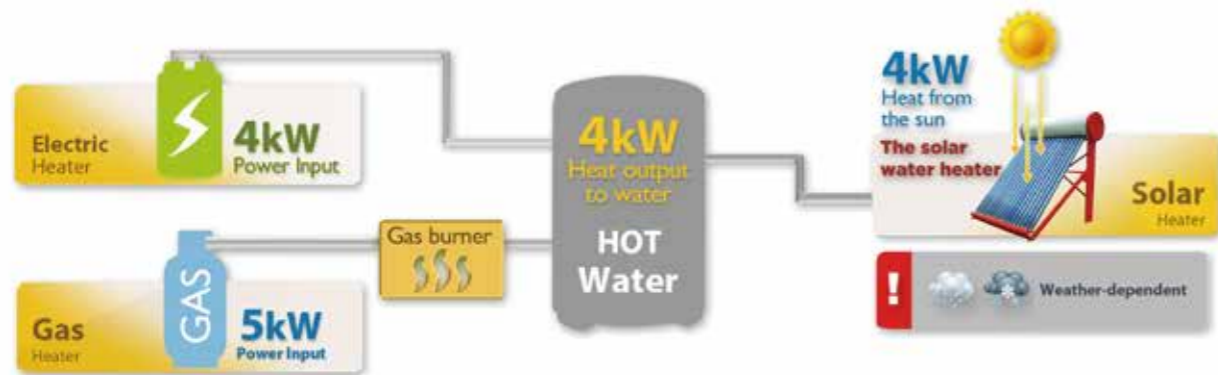

Comparison of energy sources

	Midea air source heat pump	Gas boiler	Electric water Heater	Diesel boiler	Solar water heater
Energy source	Air and electricity	LPG	Electric	Diesel	Sun and electricity
Calorific value	860kcal/kWh	24000kcal/m ³	860kcal/kWh	10200kcal/kg	860kcal/kWh
Average efficiency	3.5	0.8	0.95	0.7	2.7
Consumption*	13.33kWh	2.08m ³	49.13kWh	5.6kg	17.22kWh
Running cost(USD)	1.2	5.9	4.42	6.5	1.5

LPG: Liquefied Petroleum Gas

1. Products tested under controlled conditions at Midea laboratories.

2. * 40,000kcal are required to heat 1 ton of water from 15°C to 55°C.

How air source heat pump works

Heat pump units are capable of extracting heat from the surrounding air and transferring this heat indoors for space heating and domestic hot water.



1 Stage One

As the refrigerant passes through the expansion valve and expands, its temperature and pressure both drop.

2 Stage Two

With the temperature of the refrigerant being lower than the ambient temperature, heat passes from the air flowing over the air side heat exchanger to the refrigerant and the refrigerant evaporates.

3 Stage Three

When the refrigerant vapor passes through the compressor, refrigerant pressure increases and temperature rises above that of the water in hydronic system.

4 Stage Four

As the hot vapor refrigerant passes through the water side heat exchanger it heats the water in the hydronic system, which is then pumped indoors to the space heating terminals or hot water tank. The refrigerant cools and condenses and then ready to return to the expansion valve to start the cycle again.

M thermal

TOTAL SOLUTION FOR HEATING, COOLING AND DOMESTIC HOT WATER

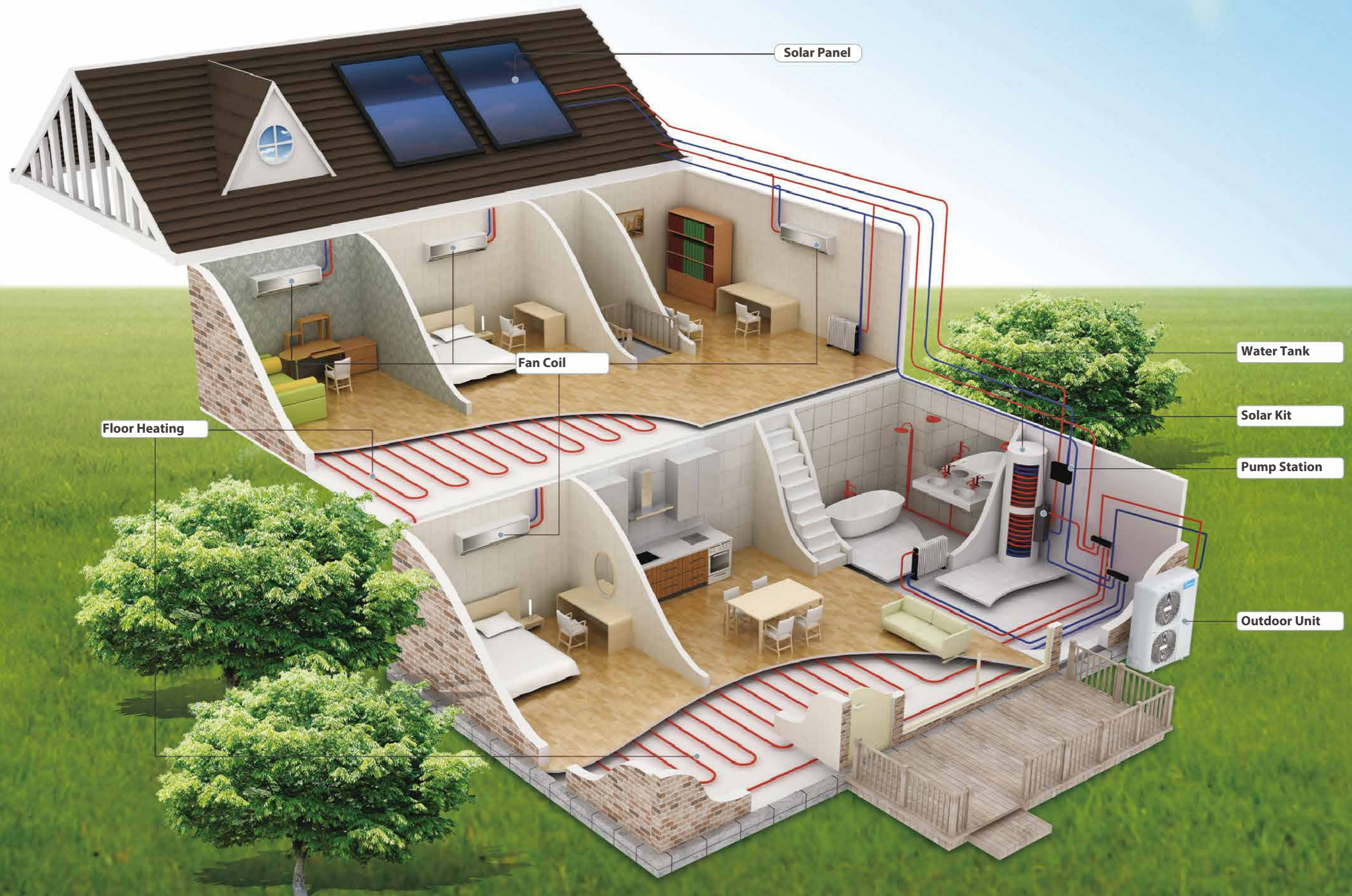

Overview



The M thermal range offers the flexibility to either have the hydronic components installed indoors or outdoors. M thermal has two different refrigerant series: R32 & R410A. With M thermal Mono, the hydronic components are integrated into the outdoor unit, offering ease of installation, whilst with M thermal Split the hydronic components are contained in a separate hydronic box, offering more installation flexibility. Both the Mono and Split products are rated A+++ on the energy efficiency and make a significant contribution to limiting the impact on the environment.

Nomenclature

Hydronic box for S series and E series

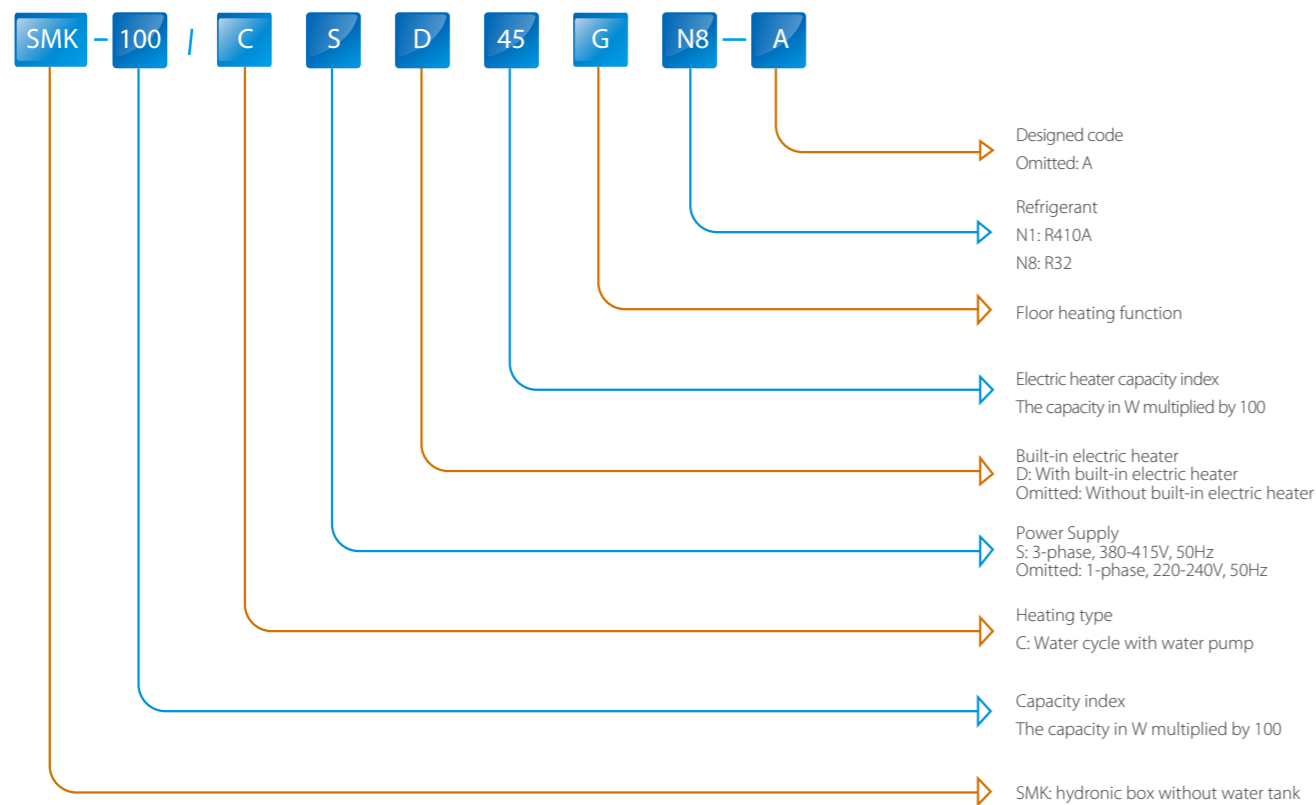

Hydronic box for A series

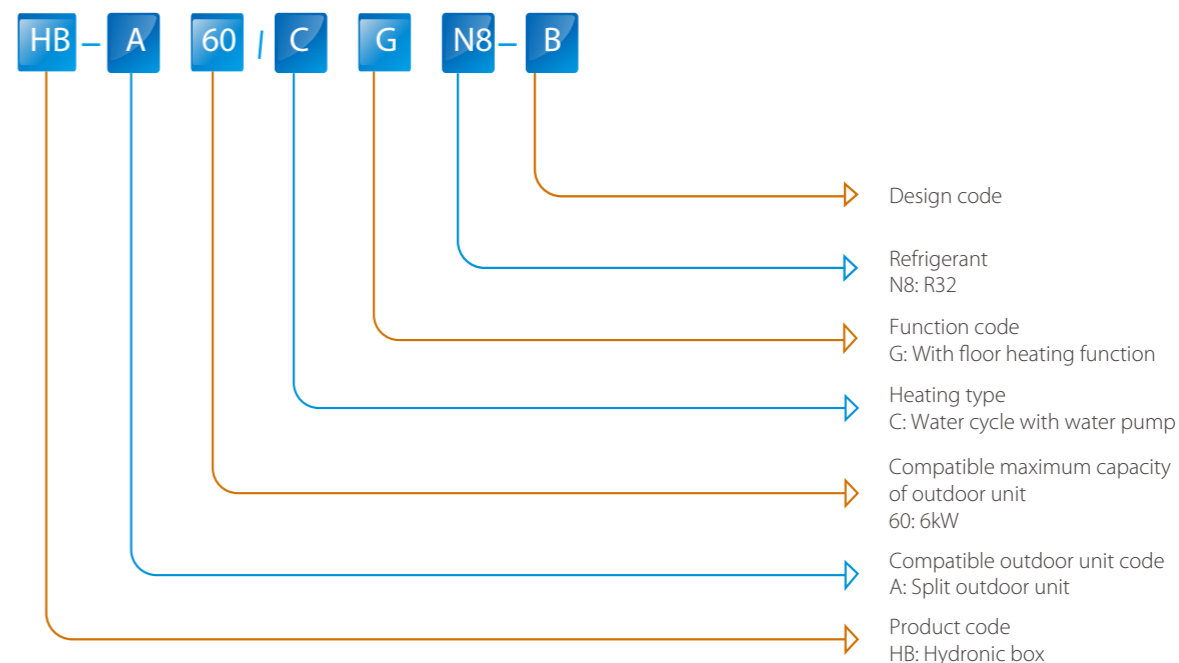

Outdoor units

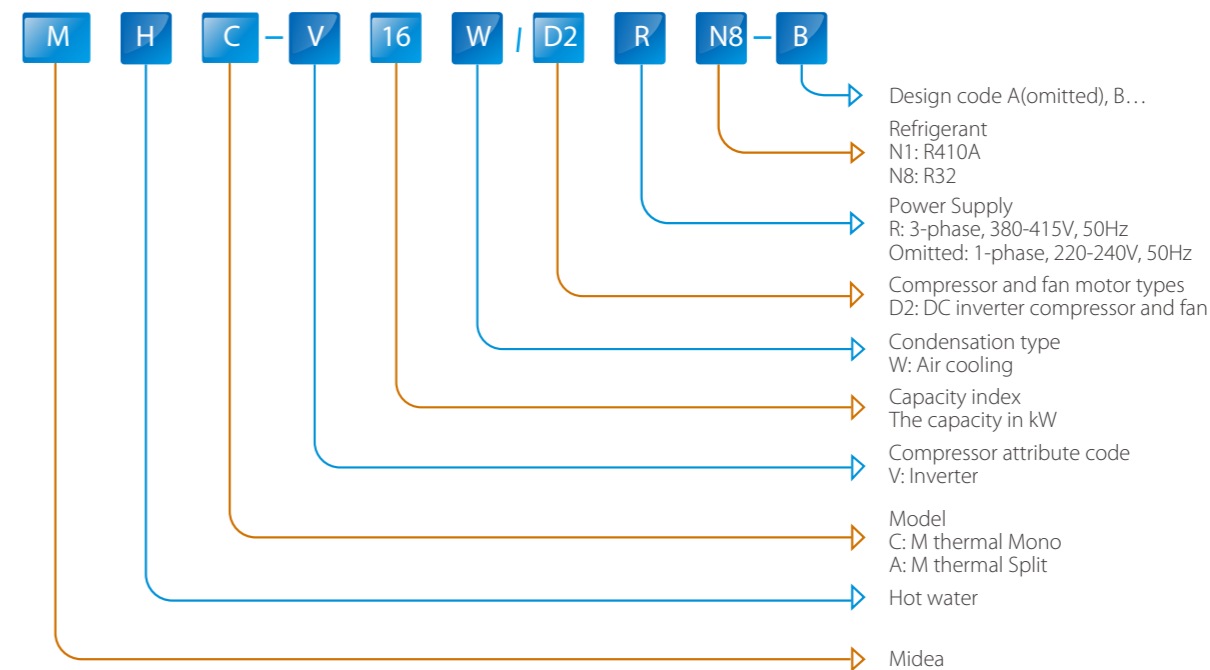

Product lineup

Mono	Capacity (kW)	4	5	6	7	8	9	10	12	14	16	18	22	26	30
	220~240V-1Ph		•	••	•	••	•	••	••	•••	•••	•••			
380~415V-3Ph									•••	•••	•••	•	•	•	•

Split Outdoor unit	Capacity (kW)	4	6	8	10	12	14	16
	220~240V-1ph		•••	•••	•••	•••	••	••
380~415V-3Ph						••	••	••

Split Hydronic box	Power supply	Hydronic box	
	220~240V-1ph	•••	
	380~415V-3Ph	•	

• S series using R410A • E series using R32 • A series using R32

M thermal Mono

<p>M thermal Mono System</p>	<p>Solar panel (field supplied)</p> <p>User interface</p> <p>Low temperature radiator (field supplied)</p> <p>Under-floor heating (field supplied)</p> <p>Mono unit</p> <p>Domestic hot water tank (field supplied)</p>
<p>Application</p>	<p>Heating + Cooling + Domestic hot water</p>
<p>Structure type</p>	<p>Integrated (Heat pump and hydronic box are in the same casing)</p>
<p>Refrigerant piping</p>	<p>Inside unit</p>
<p>Water piping</p>	<p>Between unit and indoor heating appliances</p>
<p>Installation</p>	<p>Only need to install water piping</p>
<p>Combinational parts (field supplied)</p>	<p>Under-floor heating coils Fan coil units Low temperature radiators Domestic hot water tank Auxiliary heat sources (such as water heaters and boilers)</p>

Mono unit

Mono unit absorbs heat from the outside air and transfers it to the water in the hydronic modular, through water to supply heat to indoor side.

Domestic hot water tank

Hot water from the Mono unit is circulated around the domestic hot water tank's heating water coil, heating the domestic hot water inside the tank. Immersion heaters are often installed in domestic hot water tanks as a backup.

User interface

User interface is connected to the Mono unit through signal wire; it mainly uses for ON/OFF the unit, mode setting, temperature adjusting and timer setting.

M thermal Split

<p>M thermal Split System</p>	<p>Solar panel (field supplied)</p> <p>User interface (external, apply to S and E Series Hydronic box)</p> <p>Low temperature radiator (field supplied)</p> <p>Under-floor heating (field supplied)</p> <p>Split outdoor unit</p> <p>Hydronic box (user interface integrated design for A Series)</p> <p>Domestic hot water tank (field supplied)</p>
<p>Application</p>	<p>Heating + Cooling + Domestic hot water</p>
<p>Structure type</p>	<p>Split (Heat pump and hydronic box are independent)</p>
<p>Refrigerant piping</p>	<p>Between heat pump unit (outdoor) and hydronic box (indoors)</p>
<p>Water piping</p>	<p>Between hydronic box and indoor heating appliances</p>
<p>Installation</p>	<p>Refrigerant piping and water piping</p>
<p>Combinational parts (field supplied)</p>	<p>Under-floor heating loops Fan coil units Low temperature radiators Domestic hot water tank(external, apply to SMK) Auxiliary heat sources (such as water heaters and boilers)</p>

Split type outdoor unit

The outdoor unit absorbs heat from the outside air and transfers it inside through the refrigerant piping.

Hydronic box

The hydronic box heats the water by refrigerant from outdoor unit. The heated water circulates through heating apparatus such as floor heating, radiators, fan coil units as well as inner coil of domestic hot water tank.

Domestic hot water tank

Hot water from the Split unit is circulated around the domestic hot water tank's heating water coil, heating the domestic hot water inside the tank. Immersion heaters are often installed in domestic hot water tanks as a backup.

User interface

User interface is connected to the Split unit through signal wire. It mainly uses for ON/OFF the unit, mode setting, temperature adjusting and timer setting.

Features

DC Inverter Technology

❖ Guarantee efficiency

The motors traditionally used in heat pumps run at full power even during part-load operation, wasting energy. Midea's M thermal products use DC inverter technology, which allows precise control of motor speed, ensuring that only the power necessary to perfectly match the real load is used.

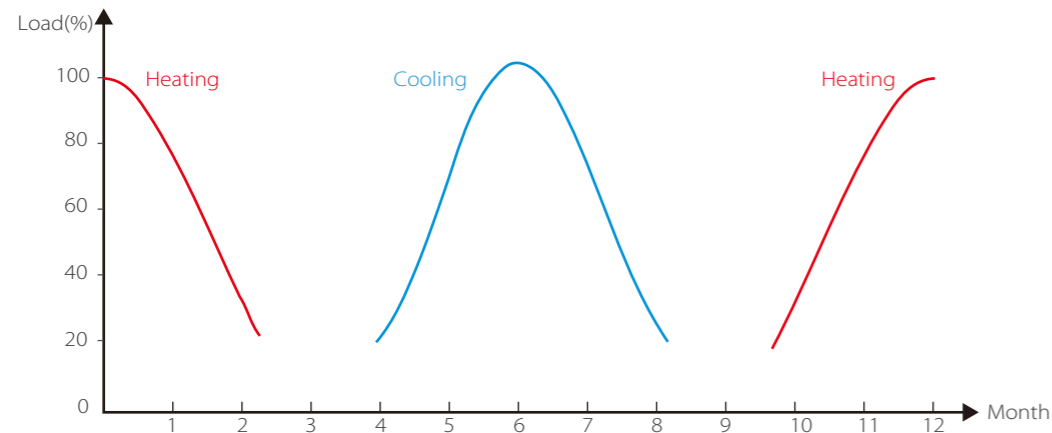

❖ Stable water temperature improves comfort

Precise control of the compressor rotation speed ensures that the water temperature is maintained within a much smaller range around the set temperature than is possible with non-inverter systems.

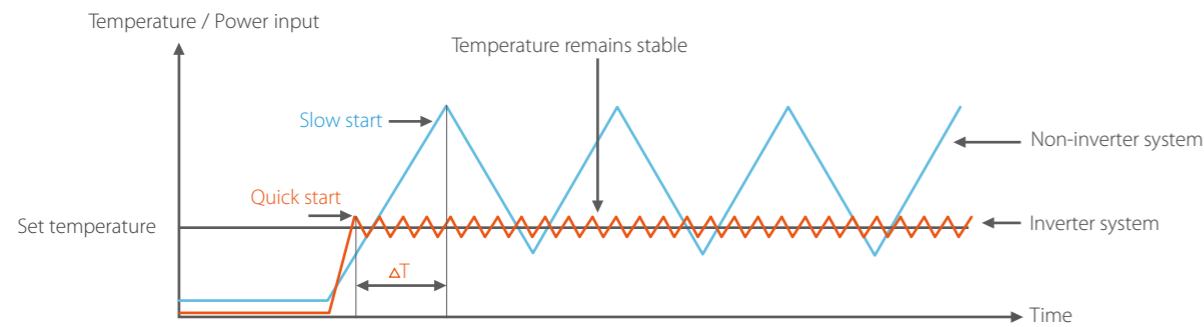

❖ Quick start-up

Inverter system output power according to the energy demand by adjusting motor rotary frequency, so it possible to achieve comfort conditions in less time than system without inverter, start-up time reduced.

❖ Less frequent start/stop

The ability to vary compressor speed (as opposed to simple on/off control) means that the compressors experience fewer start/stop cycles which expands compressor lifespan and reduces noise.

❖ Quiet operation

Most of the time, the capacity required for heating/cooling is lower than the peak load condition, meaning that heat pumps work under part-load conditions most of the time. With DC inverter compressors adjusting rotation speed according to the actual load requirement, noise levels are lower than with traditional compressor technology.

High efficiency and wide operating range

- ❖ Spray liquid cooling control of compressor is benefit for enhancing heating capacity in low temperature condition.
- ❖ S series: Offers heating capacity of 80% at -7°C thanks to the large heat exchanger and large compressor.
- ❖ E series: Offers heating capacity of 100% at -7°C thanks to the large heat exchanger and large compressor.
- ❖ A series: Offers heating capacity of 100% at -10°C thanks to the large heat exchanger and large compressor.

Twin rotary compressor

Twin rotary DC inverter compressor uses 30% less power than traditional scroll compressors whilst also giving a wider operating frequency range, enabling precise control and reducing running noise levels.

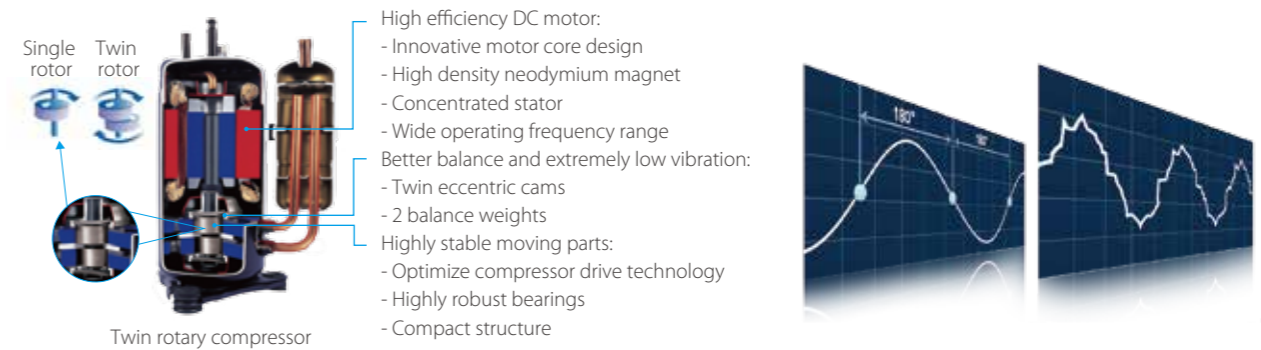

Finned tube heat exchanger

High performance fin-coil type heat exchanger is adopted at air side. Flat fin strengthens the low temperature heating capacity and effectively reduces capacity attenuation. Hydrophilic film fins and inner-threaded copper pipes optimize heat exchange efficiency. The specially coated blue fins enhance durability and protect against corrosion from air, water and other corrosive agents, assures a longer coil service life.

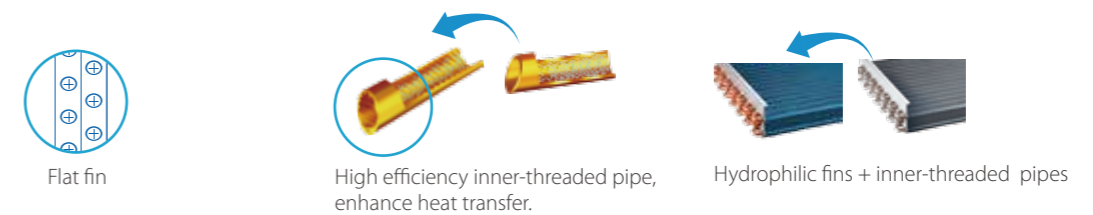

Hydronic module

Integrated hydronic module with DC water pump and backup electric heater.

Brushless DC fan motor

Stepless fan motor control enables super-quiet fan operation and minimizes power consumption.



- ❖ For E series and A series and S series model MHC-V5(7/9)W/D2N1, backup electric heater is customizable whilst other S series models are standard mounted for additional heating during extremely cold weather. The capacity of the backup electric heater is customizable and the output capacity is adjustable.

- ❖ Heating, cooling and domestic hot water: a total heat solution.
- ❖ Compatible with additional heat sources (AHSs) including solar water heaters and boilers. AHSs can work together with heat pump or alternative for space heating and domestic hot water dependent on the system control.

❖ Wide ambient temperature and water temperature operation ranges.

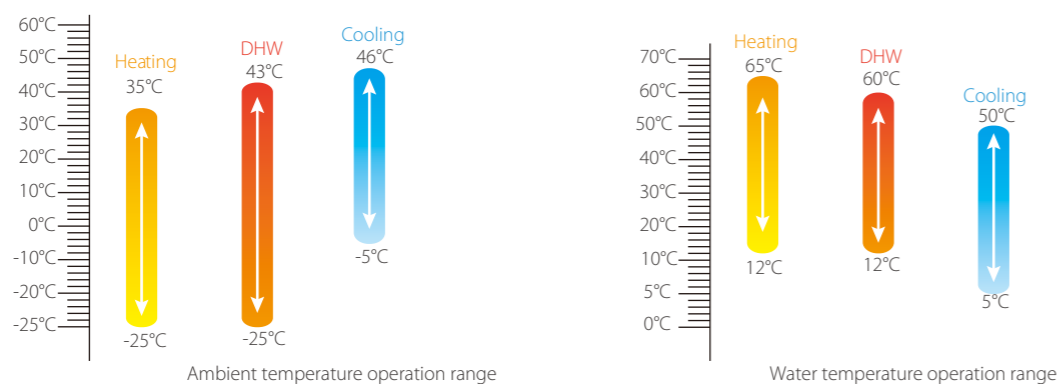

Easy installation and easy maintenance

- ❖ All hydronic components are located within the outdoor unit (Mono models).
- ❖ Refrigerant system entirely contained within outdoor unit - no additional refrigerant piping required (Mono models).
- ❖ Compact structure, easy for transportation and installation.
- ❖ Two-door design for easy access to internal components for easy maintenance (Take an example as A Series 8-16kW).



Door 1: Access to hydronic components and electrical parts

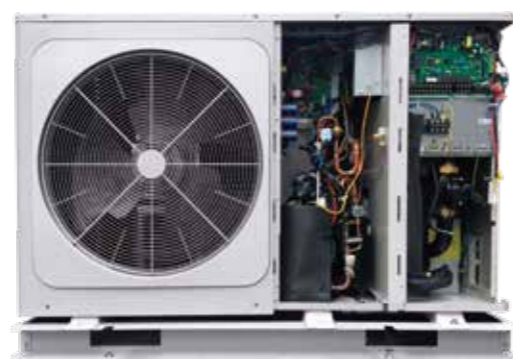

Door 2: Access to refrigerant components and electrical parts.

- ❖ E Series and A Series Split: Additional refrigerant charge only required if refrigerant piping length exceeds 15m.
- ❖ S Series Split: Additional refrigerant charge only required if refrigerant piping length exceeds 10m.
- ❖ 270mm thinnest size for A Series Split indoor unit.

Ideal transformation plan for gas burner and convenient for replacing.
Rotating electric control box enables easy maintenance access to all hydronic components.



270mm thinnest!



Electric box
Built-in backup electric heater (optional for E Series and A Series) uses for additional heating during extremely cold weather. The output capacity is adjustable.
Drain pan fitted as standard.
Drain pan

Flexible operation and more comfort

❖ Weather dependent operation with climate correlation to ensure absolute comfort. Totally there are 32 climate correlation curves for choice and custom curve is optional. Once the curve is selected, the unit set the outlet water temperature automatically according to the outdoor ambient temperature.

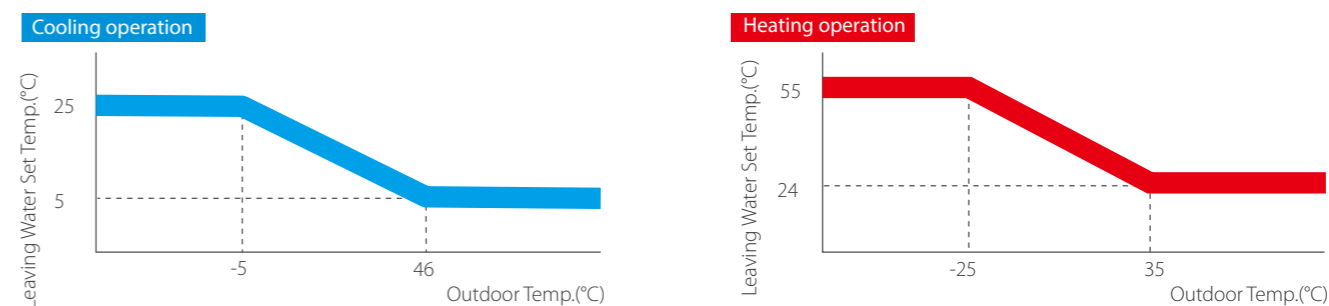

- ❖ Zones control more flexibility
Temperature of each zone is separately controlled. Two zones control reduces water pump cycle time and save energy.
Two zones controlled using user interface only (take an example as Mono)

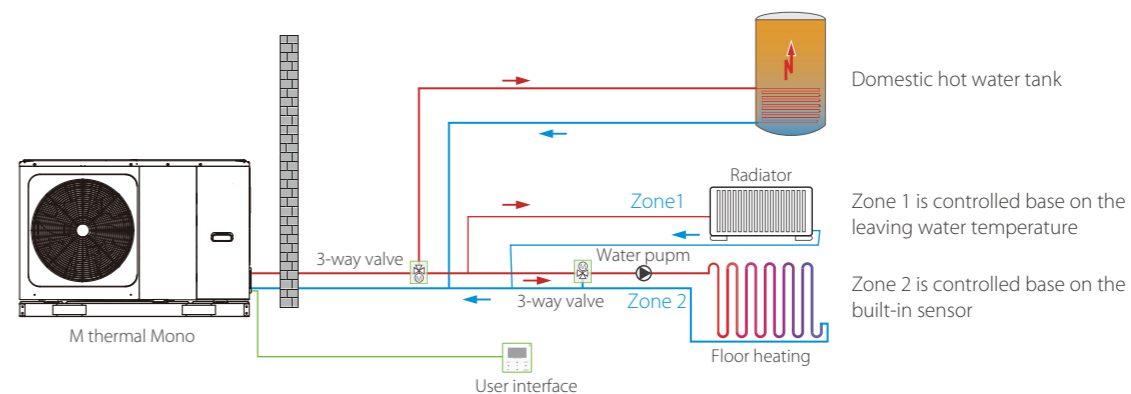

Two zones controlled using user interface and thermostat (take an example as Split)

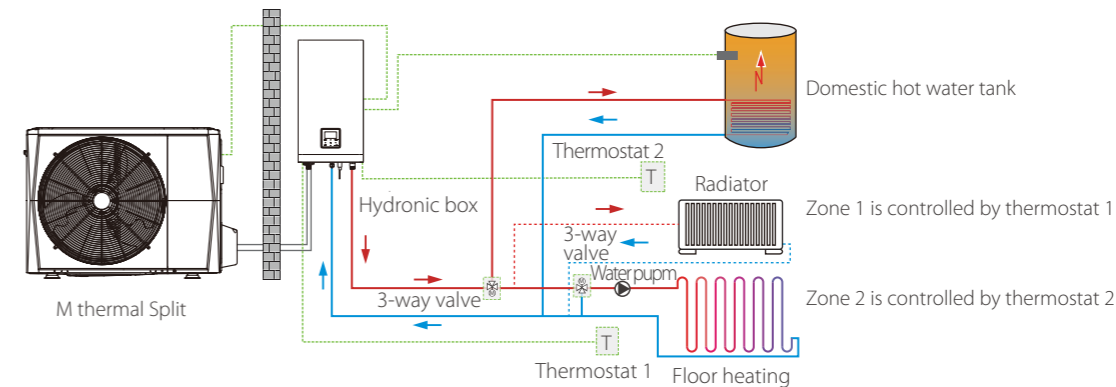

- ❖ Priority setting function and multi modes choice



Note:
1. Only when the immersion heater of tank is available can the disinfection mode be used.

- ❖ Special functions such as air purge, preheating for floor and floor drying up

User interface



- ❖ Newly designed touch-key wired controller
- ❖ Check running parameters in real time
- ❖ Communication wire length up to 50m
- ❖ Built-in temperature sensor
- ❖ Built-in wifi module (For E series and A series)
- ❖ Multiple languages (For E series and A series)
- ❖ Modbus protocol and network flexibility (For S series and E series; For A series, available on May 31 ,2020)
- ❖ Maximum 6 units controlled by one controller with automatic addressing(For A series Mono, available on May 31,2020)

M thermal Mono

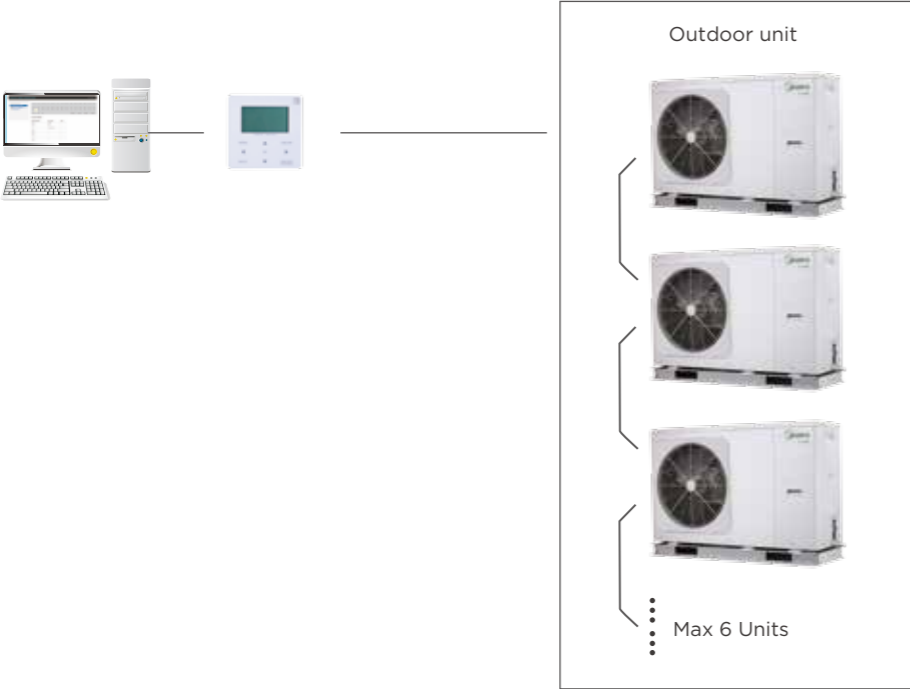

Smart Grid function(E series and A series)

Unit adjusts the operation according to the peak and valley power with different electrical signals to decrease operation cost.

Free electric energy signal: DHW mode turn on, the setting temperature will be changed to 70 C automatically, and the TBH operate. The unit operate in cooling/heating mode as the normal logic.

Common electric energy signal: unit operates according to users' need.

Expensive electric energy signal: only available for cooling or heating mode and user can set the maximum operating time.



M Smartlife APP control (E series and A series)

Remote control

Check the running state of equipment, zone switch, operation mode and temperature.

Set switch, operation mode and temperature of each zone

Display fault information

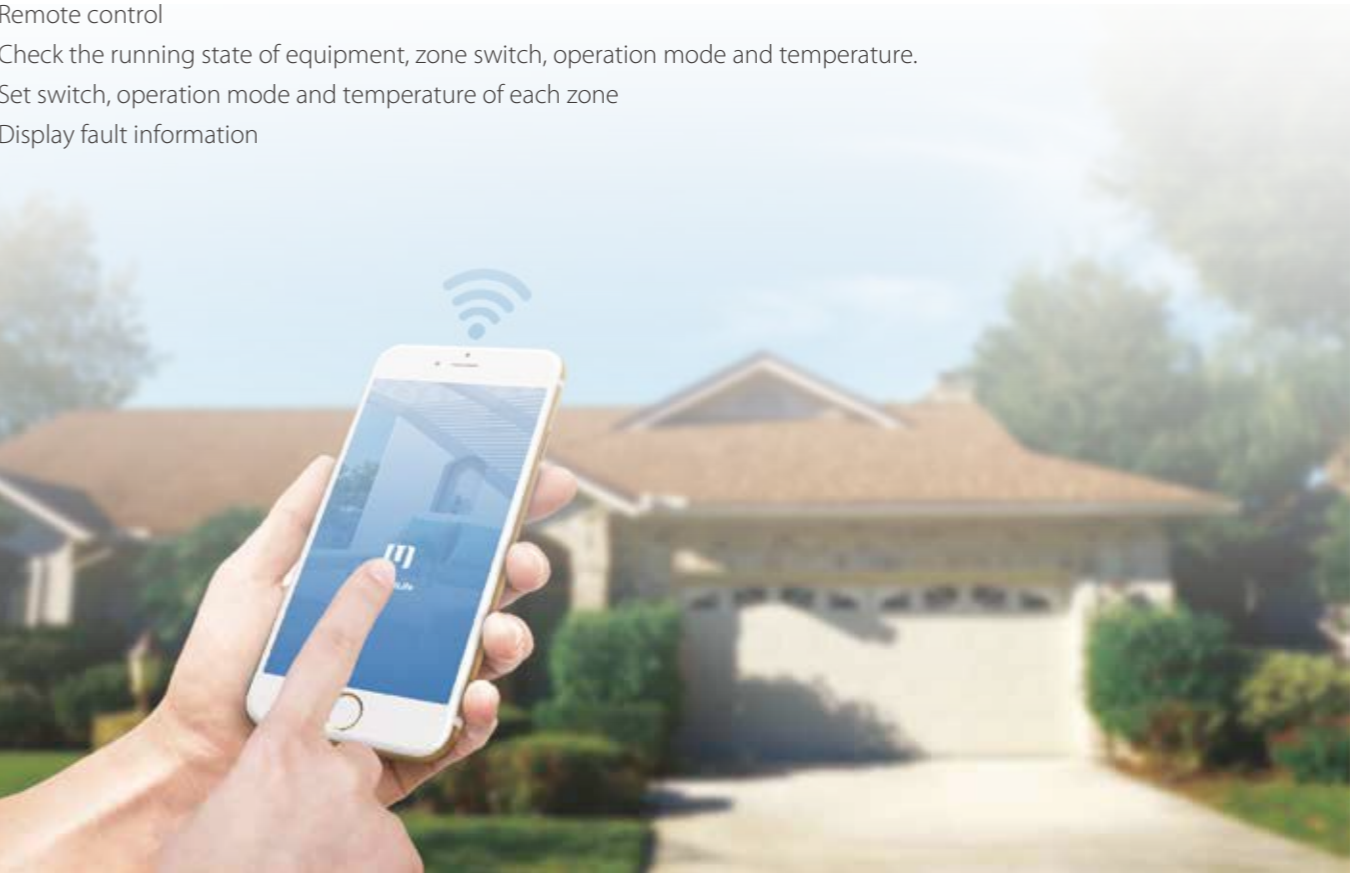

Typical Applications

System configurations

M thermal system can be configured to run with the electric heater either enabled or disabled and can also be used in conjunction with an auxiliary heat source such as a boiler.

The chosen configuration affects the size of heat pump that is required. Three typical configurations are described below.

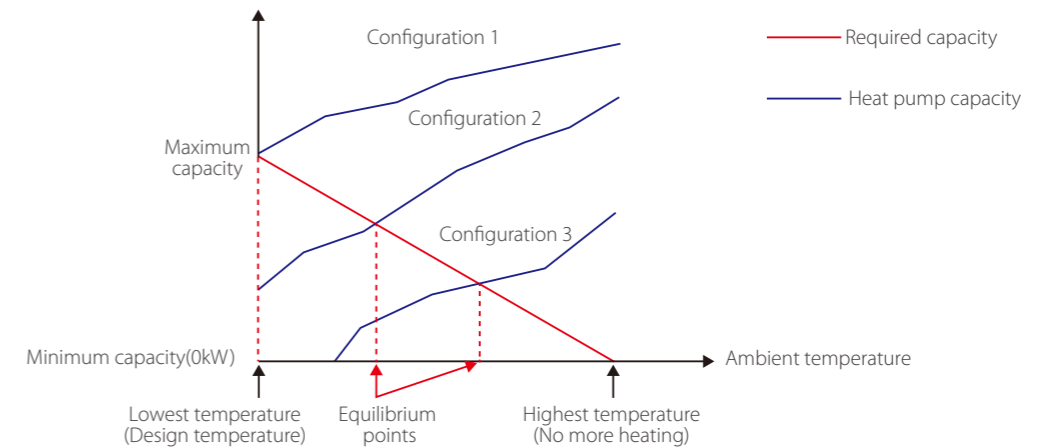

Configuration 1: Heat pump only

- ❖ The heat pump covers the required capacity and no extra heating capacity is necessary.
- ❖ Requires selection of larger capacity heat pump and implies higher initial investment.
- ❖ Ideal for new construction in projects where energy efficiency is paramount.

Configuration 2: Heat pump and backup electric heater

- ❖ Heat pump covers the required capacity until the ambient temperature drops below the point at which the heat pump is able to provide sufficient capacity. When the ambient temperature is below this equilibrium point, the backup electric heater supplies the required additional heating capacity.
- ❖ Best balance between initial investment and running costs, results in lowest lifecycle cost.
- ❖ Ideal for new construction.

Configuration 3: Heat pump with auxiliary heat source

- ❖ Heat pump covers the required capacity until the ambient temperature drops below the point at which the heat pump is able to provide sufficient capacity. When the ambient temperature is below this equilibrium point, depending on the system settings, either the auxiliary heat source supplies the required additional heating capacity or the heat pump does not run and the auxiliary heat source covers the required capacity.
- ❖ Enables selection of lower capacity heat pump.
- ❖ Ideal for refurbishments and upgrades.

Extremely silent

- ❖ Two level of silent mode provides more comfort

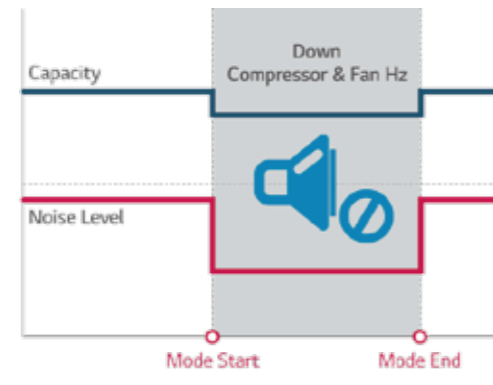

- ❖ Single fan structure for big capacity with lower noise (For A series silent mode)



Extremely silent!

53dB

Notes: The corresponding sound pressure is about 35~40dB, just like whispering softly.
With a sound pressure of only 35 decibels outside of 3m, it feels as quiet as sleeping or being in the library.

USB function(For A Series)

- ❖ Convenient program upgrade
No need to carry any other heavy equipments but only USB can realize program upgrade of indoor unit and outdoor unit.
- ❖ Parameter setting transmission between wired controllers
Installer can quickly copy the setting from one controller to another via USB, which save the time of on-site installation.



Selection Procedure

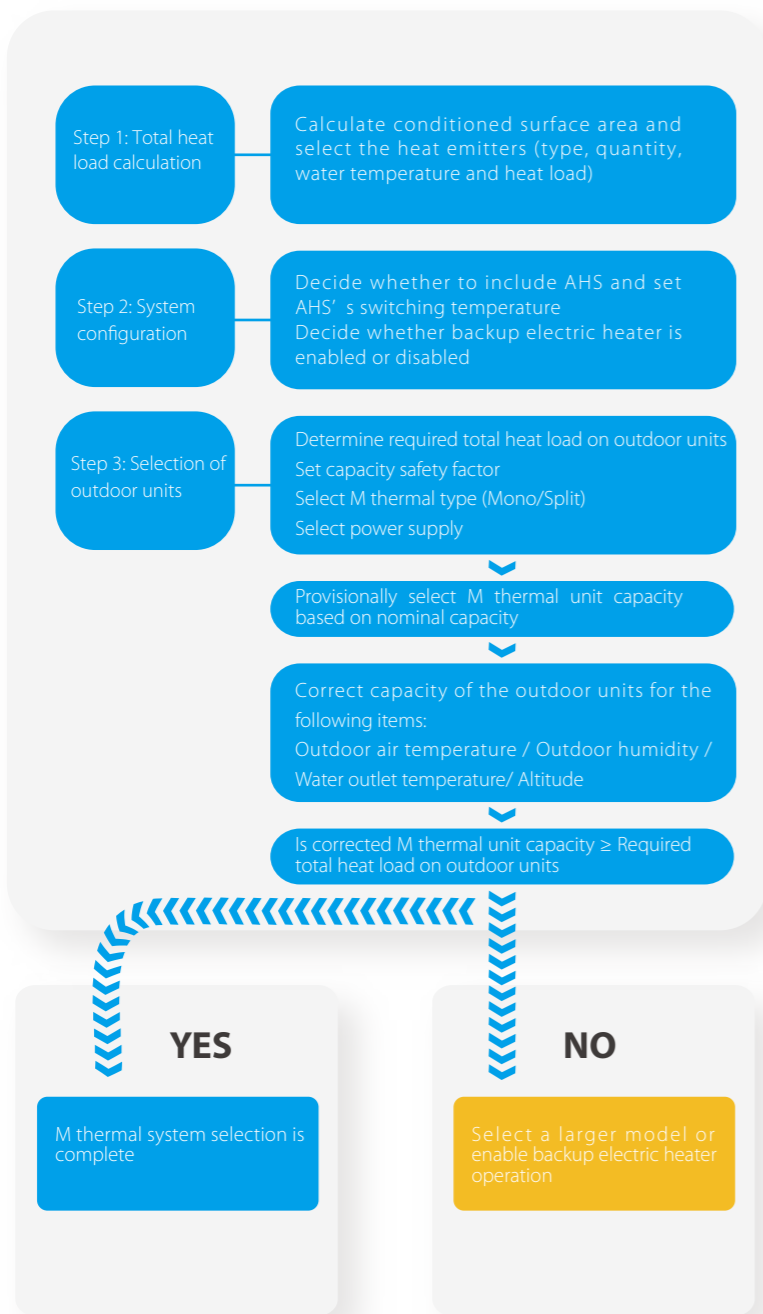

Leaving Water Temperature (LWT)

The recommended design LWT ranges for different types of heat emitter are:

- ❖ For floor heating: 30°C to 35°C
- ❖ For fan coil units: 40°C to 45°C
- ❖ For low temperature radiators: 40°C to 50°C

Total heat solution - Heating, cooling and domestic hot water in one system

M thermal is an integrated system that provides space heating and cooling as well as domestic hot water, offering a complete, all-year-round solution which can remove the need for traditional gas or oil boilers, or work together with them.



M thermal Mono outdoor unit

- ❖ The outside air is a renewable source of energy
- ❖ DC inverter technology enables high energy efficiency
- ❖ Sufficient heating capacity at low ambient temperatures (even at -25°C)
- ❖ Provide space heating, cooling and domestic hot water, total heat solution
- ❖ Compatible with other heat sources such as solar panels and boilers



Typical Applications Take an example as S series Mono

❖ Application 1: Space Heating Only

The room thermostat is used as a switch. When there is a heating request from the room thermostat, the Mono unit operates to achieve the target water temperature set on the user interface. When the room temperature reaches the thermostat's set temperature, the unit stops.

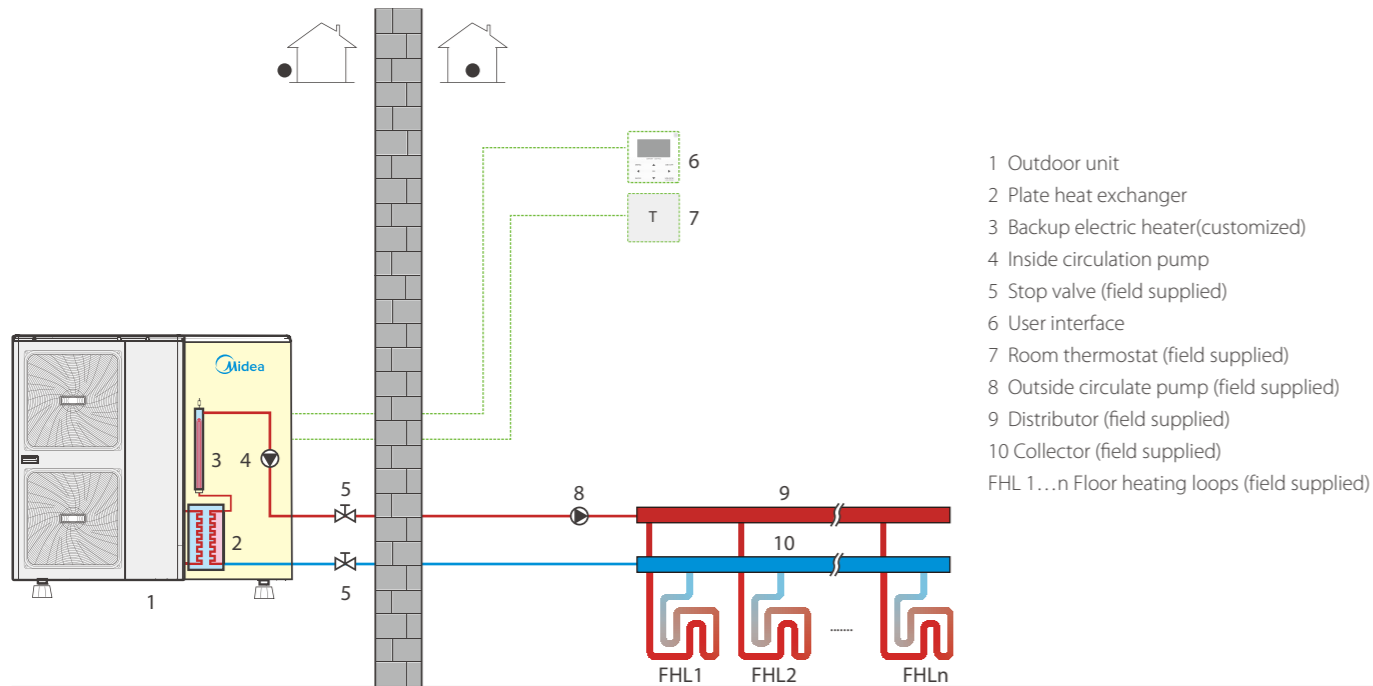

❖ Application 2: Space Heating and Domestic Hot Water

The room thermostats are not connected to the Mono unit but to a motorized valve. Each room's temperature is regulated by the motorized valve on its water circuit. Domestic hot water is supplied from the domestic hot water tank connected to the Mono unit. A bypass valve is required.

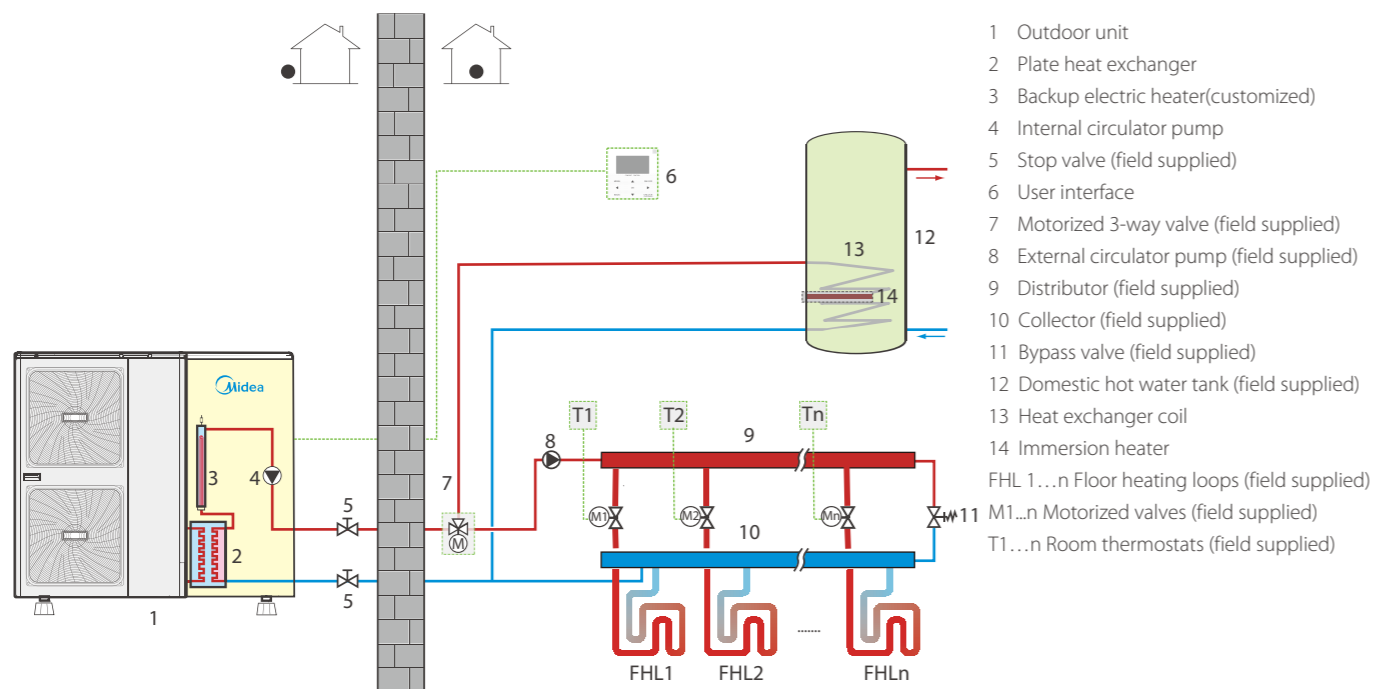

Typical Applications Take an example as E series Split

❖ Application 1: Space Heating Through Floor Heating Loops and Fan Coil Units

The floor heating loops and fan coil units require different operating water temperatures. To achieve these two set points, a mixing station is required. Room thermostats for each zone are optional.

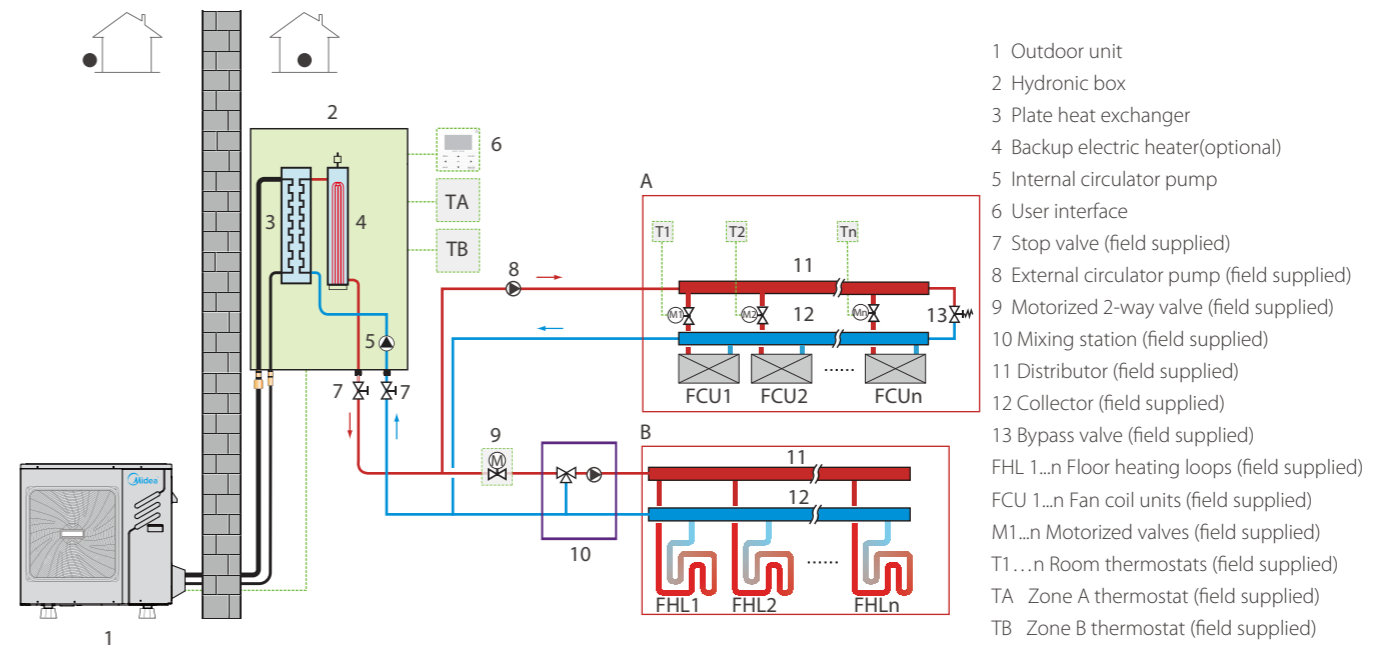

❖ Application 2: Auxiliary heat source provides additional heating

If the unit's outlet temperature is too low, the auxiliary heat source provides additional heating to raise the water temperature to the set temperature. An additional 3-way valve is required. When the unit's outlet temperature is too low, the 3-way valve is open and the water flows through the auxiliary heat source. When the unit's outlet temperature is high enough, the 3-way valve is closed.

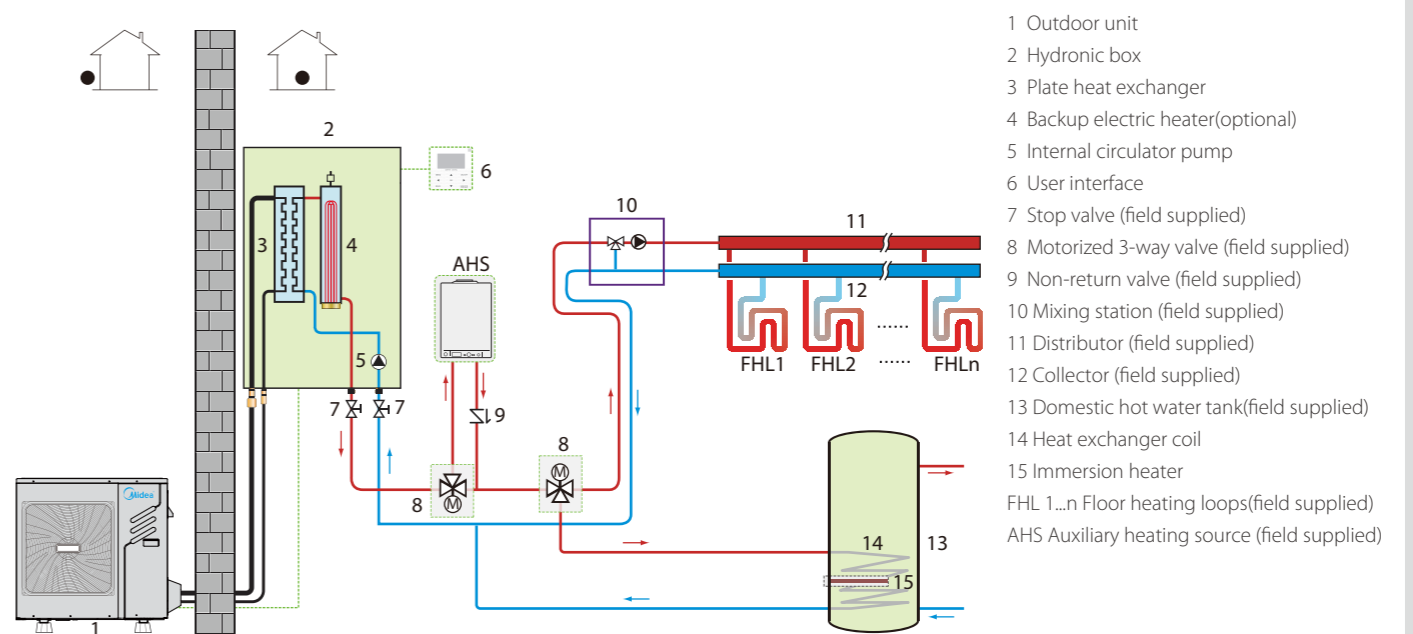

Typical Applications

Take an example as A series Split

❖ Application 1: Space Heating Through Floor Heating Loops and Radiators

The floor heating loops and radiators require different operating water temperatures. To achieve these two points, a mixing station is required. Room thermostats for each zone are optional. With the help of hydronic adapter board (optional), maximum 8 thermostats for 8 rooms are available to control heat pump, which greatly improves the operation convenience.

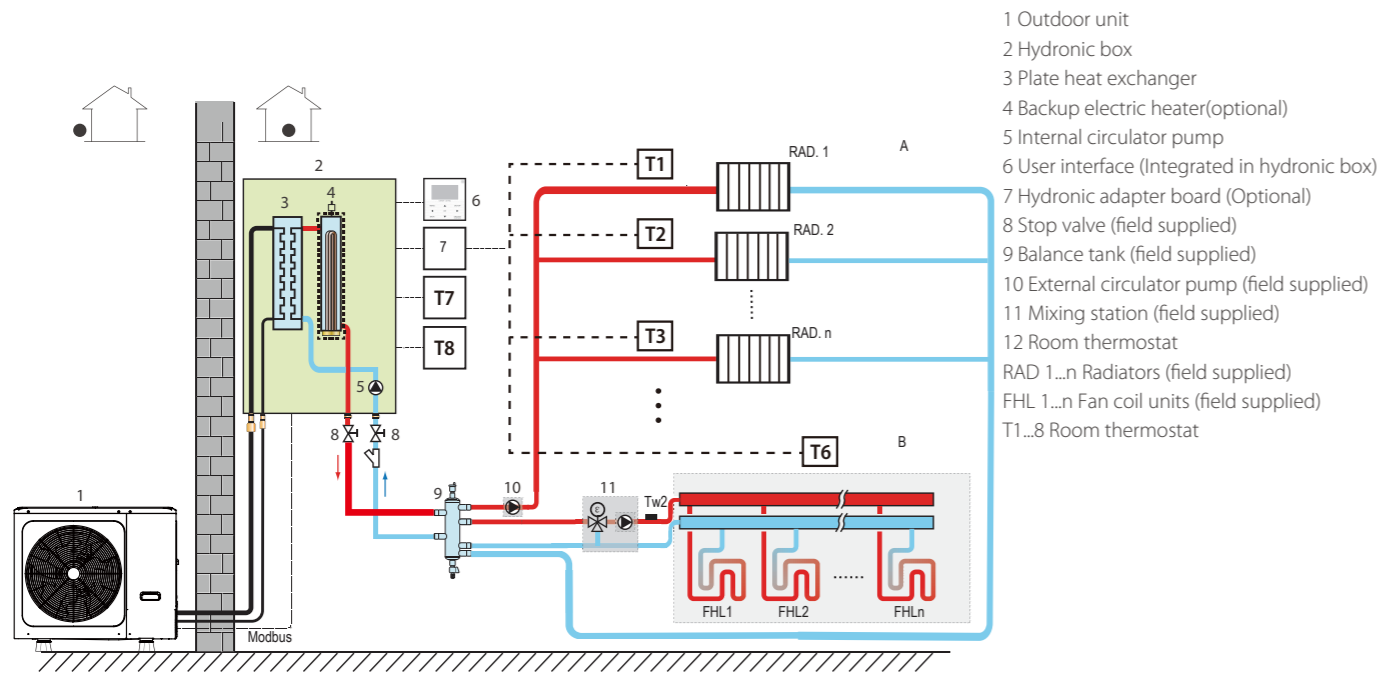

- 1 Outdoor unit
- 2 Hydronic box
- 3 Plate heat exchanger
- 4 Backup electric heater(optional)
- 5 Internal circulator pump
- 6 User interface (Integrated in hydronic box)
- 7 Hydronic adapter board (Optional)
- 8 Stop valve (field supplied)
- 9 Balance tank (field supplied)
- 10 External circulator pump (field supplied)
- 11 Mixing station (field supplied)
- 12 Room thermostat
- RAD 1...n Radiators (field supplied)
- FHL 1...n Fan coil units (field supplied)
- T1...8 Room thermostat

❖ Application 2: Space Heating, Space Cooling and Domestic Hot Water Compatible with Solar Water Heater

Floor heating loops and fan coil units are used for space heating and fan coil units are used for space cooling. Domestic hot water is supplied from the domestic hot water tank connected to both the hydronic box and solar water heater. Solar water pump is controlled by Tsolar temperature sensor. Balance tank temperature sensor is used to control on/off of heat pump. Once the heat pump stops, internal pump stops to save energy and then balance tank provides hot water for space heating. In addition, balance tank temperature control can meet both space heating and domestic hot water needs at the same time.

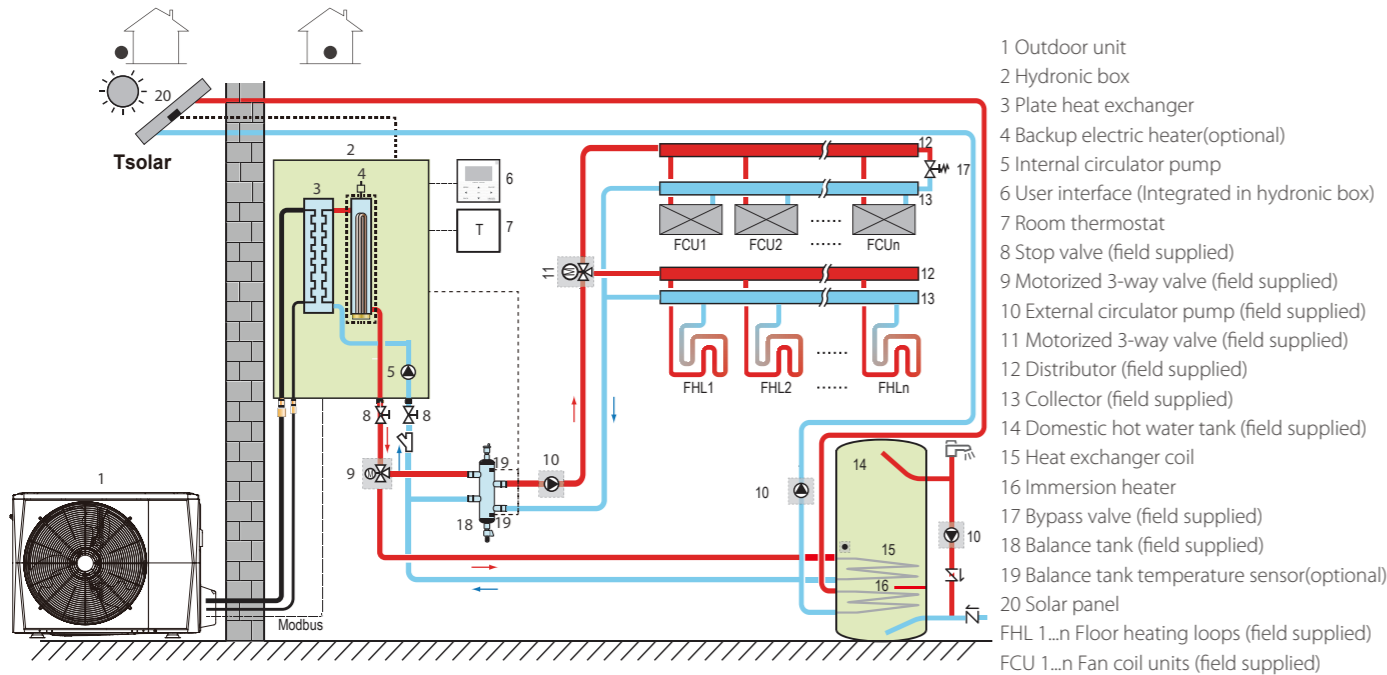

- 1 Outdoor unit
- 2 Hydronic box
- 3 Plate heat exchanger
- 4 Backup electric heater(optional)
- 5 Internal circulator pump
- 6 User interface (Integrated in hydronic box)
- 7 Room thermostat
- 8 Stop valve (field supplied)
- 9 Motorized 3-way valve (field supplied)
- 10 External circulator pump (field supplied)
- 11 Motorized 3-way valve (field supplied)
- 12 Distributor (field supplied)
- 13 Collector (field supplied)
- 14 Domestic hot water tank (field supplied)
- 15 Heat exchanger coil
- 16 Immersion heater
- 17 Bypass valve (field supplied)
- 18 Balance tank (field supplied)
- 19 Balance tank temperature sensor(optional)
- 20 Solar panel
- FHL 1...n Floor heating loops (field supplied)
- FCU 1...n Fan coil units (field supplied)

Specifications

S series Mono



Model MHC-		V5W/D2N1	V7W/D2N1	V9W/D2N1	V10W/D2N1	V12W/D2N1	V14W/D2N1	V16W/D2N1	V12W/D2RN1	V14W/D2RN1	V16W/D2RN1	
Power supply		V/Ph/Hz	220-240/1/50								380-415/3/50	
Heating ²	Capacity	kW	4.58	6.55	8.64	10.43	12.17	14.76	16.33	12.37	14.10	16.30
	Rated input	kW	0.97	1.45	2.01	2.28	2.73	3.40	3.90	2.76	3.26	3.88
	COP		4.72	4.52	4.30	4.57	4.46	4.34	4.19	4.48	4.33	4.20
Heating ³	Capacity	kW	4.67	6.69	9.19	10.17	12.58	14.08	16.12	12.02	14.11	16.06
	Rated input	kW	1.43	2.05	2.63	3.08	3.86	4.47	5.22	3.72	4.46	5.23
	COP		3.27	3.26	3.49	3.30	3.26	3.15	3.09	3.23	3.16	3.07
Cooling ⁴	Capacity	kW	4.55	6.45	8.35	10.25	12.19	14.61	14.82	12.64	14.03	15.10
	Rated input	kW	1.00	1.47	2.10	2.06	2.65	3.32	3.66	2.75	3.26	3.78
	EER		4.55	4.40	3.97	4.98	4.60	4.40	4.05	4.60	4.30	4.00
Cooling ⁵	Capacity	kW	4.55	6.71	8.06	10.44	12.21	12.95	13.72	12.58	13.80	15.26
	Rated input	kW	1.55	2.57	3.51	3.28	4.17	4.53	5.16	4.32	5.14	6.41
	EER		2.94	2.61	2.30	3.18	2.93	2.86	2.66	2.91	2.68	2.38
Seasonal space heating energy efficiency class ⁶		LWT at 35°C	A++									
		LWT at 55°C	A++									
Air flow		m ³ /h	3050	3050	3050	6150	6150	6150	6150	6150	6150	6150
Sound power level ⁷		dB	63	67	70	68	69	73	73	70	73	75
Net dimensions (WxHxD)		mm	1210x945x402			1404x1414x405			1404x1414x405			
Packed dimensions (WxHxD)		mm	1500x1140x450			1475x1580x440			1475x1580x440			
Net/Gross weight		kg	99/117			162/183			177/198			
Water piping connections		mm	Φ25 Female BSP			Φ32 Female BSP			Φ32 Female BSP			
Safety valve set pressure		MPa	0.3			0.3			0.3			
Total water volume		L	2.0			5.5			5.5			
Operating temperature range	Cooling	°C	-5 to 46									
	Heating	°C	-20 to 35									
	DHW	°C	-20 to 43									
LWT range	Cooling	°C	5 to 25									
	Heating	°C	25 to 60									
	DHW	°C	40 to 60									
Refrigerant	Type		R410A									
	Charged volume	kg	2.4	2.4	2.4	3.6	3.6	3.6	3.6	3.6	3.6	3.6
Throttle type			Electronic expansion valve			Electronic expansion valve			Electronic expansion valve			
Backup electric heater ⁸	Standard mounted	kW	-	-	-	3.0	3.0	3.0	3.0	4.5	4.5	4.5
	Optional	kW	3.0	3.0	3.0	4.5	4.5	4.5	4.5	-	-	-
	Capacity steps		1	1	1	2	2	2	2	1	1	1

Notes:

1. Relevant EU standards and legislation: EN14511; EN14825; EN50564; EN12102; (EU) No 811/2013; (EU) No 813/2013; OJ 2014/C 207/02:2014.
2. Outdoor air temperature 7°C DB, 85% R.H.; EWT 30°C, LWT 35°C.
3. Outdoor air temperature 7°C DB, 85% R.H.; EWT 40°C, LWT 45°C.
4. Outdoor air temperature 35°C DB; EWT 23°C, LWT 18°C.
5. Outdoor air temperature 35°C DB; EWT 12°C, LWT 7°C.
6. Seasonal space heating energy efficiency class tested in average climate conditions.
7. Testing standard: EN12102-1
8. For 5/7/9kW model, the backup electric heater is installed in an optional external box which model is BH30A while backup electric heater is built into 10/12/14/16kW model.

Operating Limits

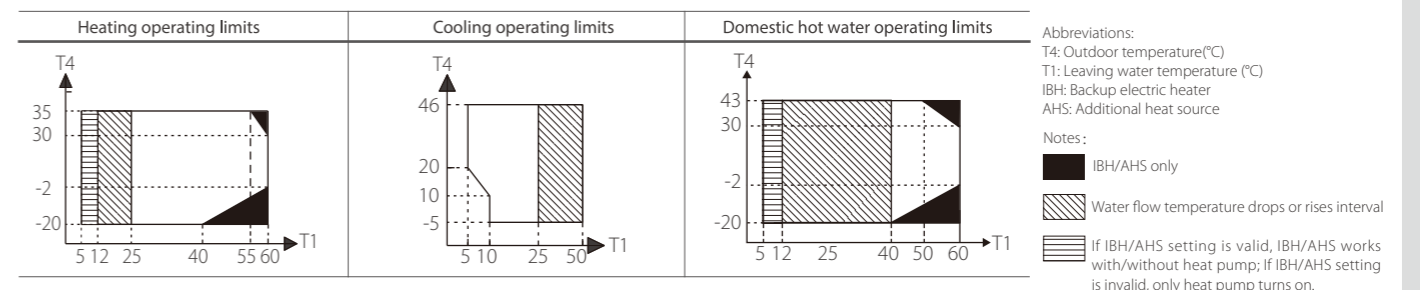

Abbreviations:
 T4: Outdoor temperature(°C)
 T1: Leaving water temperature (°C)
 IBH: Backup electric heater
 AHS: Additional heat source

Notes:
 ■ IBH/AHS only
 ▨ Water flow temperature drops or rises interval
 ▨ If IBH/AHS setting is valid, IBH/AHS works with/without heat pump; if IBH/AHS setting is invalid, only heat pump turns on.

S series Split outdoor unit



Outdoor unit model MHA-			V4W/D2N1	V6W/D2N1	V8W/D2N1	V10W/D2N1	V12W/D2N1	V14W/D2N1	V16W/D2N1	V12W/D2RN1	V14W/D2RN1	V16W/D2RN1	
Power supply	V/Ph/Hz		220-240/1/50						380-415/3/50				
Heating ²	Capacity	kW	4.10	6.10	8.00	10.00	12.10	14.00	15.50	12.00	14.00	15.50	
	Rated input	kW	0.82	1.29	1.73	2.17	2.74	3.39	3.82	2.66	3.26	3.79	
	COP		5.00	4.73	4.62	4.61	4.42	4.13	4.06	4.51	4.29	4.09	
Heating ³	Capacity	kW	4.01	5.96	7.34	10.12	11.85	14.05	16.05	11.97	13.93	15.48	
	Rated input	kW	1.13	1.68	2.13	2.93	3.48	4.41	5.03	3.50	4.21	4.87	
	COP		3.55	3.55	3.45	3.45	3.41	3.19	3.19	3.42	3.31	3.18	
Cooling ⁴	Capacity	kW	4.10	6.20	8.00	10.50	11.70	13.10	13.80	12.00	13.50	14.50	
	Rated input	kW	0.84	1.43	1.93	2.30	2.79	3.48	3.77	2.80	3.45	3.94	
	EER		4.88	4.34	4.15	4.57	4.19	3.76	3.66	4.29	3.91	3.68	
Cooling ⁵	Capacity	kW	4.12	6.15	6.44	9.39	11.02	12.49	12.85	11.70	12.53	12.91	
	Rated input	kW	1.30	2.08	2.24	3.26	4.17	5.07	5.39	4.65	5.21	5.52	
	EER		3.17	2.96	2.88	2.88	2.64	2.46	2.38	2.52	2.40	2.34	
Seasonal space heating energy efficiency class ⁶	LWT at 35°C		A+++		A++	A+++		A++		A+++		A++	
	LWT at 55°C		A++										
Sound power level ⁷	dB		62	66	69	67	69	71	72	70	72	72	
Dimension (WxHxD)	mm		960x860x380		1075x965x395		900x1327x400			900x1327x400			
Packing (WxHxD)	mm		1040x1000x430		1120x1100x435		1030x1457x435			1030x1457x435			
Net/gross weight	kg		60/72		76/88		99/112			115/126			
Compressor	Type		Twin-rotary inverter										
Outdoor fan	Type		Brushless DC motor										
	Air flow	m ³ /h	3180		5116		6500			6500			
Air side heat exchanger			Fin-coil										
Piping connections	Liquid	Type	Flaring										
		Dia.(OD)	mm		Φ9.5								
	Gas	Type	Flaring										
		Dia.(OD)	mm		Φ15.9								
	Piping length	Min.	m		2		2		2			2	
		Max.	m		20		30		50			50	
Installation height difference	OU above	m		10		20		30			30		
	OU below	m		8		15		25			25		
Refrigerant	Type	R410A											
	Charged volume	kg	2.5		2.8		3.9			4.2			
Throttle type		Electric expansion valve											
Operating temperature range	Cooling	°C	-5 to 46										
	Heating	°C	-20 to 35										
	DHW	°C	-20 to 43										

Notes:

- Relevant EU standards and legislation: EN14511; EN14825; EN50564; EN12102; (EU) No 811/2013; (EU) No 813/2013; OJ 2014/C 207/02:2014.
- Outdoor air temperature 7°C DB, 85% R.H.; EWT 30°C, LWT 35°C.
- Outdoor air temperature 7°C DB, 85% R.H.; EWT 40°C, LWT 45°C.
- Outdoor air temperature 35°C DB; EWT 23°C, LWT 18°C.
- Outdoor air temperature 35°C DB; EWT 12°C, LWT 7°C.
- Seasonal space heating energy efficiency class tested in average climate conditions.
- Testing standard: EN12102-1.

S series Split hydronic box



Hydronic box	Model	SMK-80/CD30GN1-B	SMK-160/CD30GN1-B	SMK-160/CSD45GN1-B	
	Compatible outdoor unit model	MHA-V4(6, 8)W/D2N1	MHA-V10/12/14/16W/D2N1	MHA-V12/14/16W/D2RN1	
Function		Heating and cooling			
LWT range	Space heating	Low	°C		25 to 55
		High	°C		35 to 60
	Space cooling	Low	°C		5 to 25
		High	°C		18 to 25
DHW	°C		40 to 60		
Power supply	V/Ph/Hz	220-240/1/50	220-240/1/50	380-415/3/50	
Sound power level ¹	dB	43	45	45	
Dimension (WxHxD)	mm	400x865x427			
Packing (WxHxD)	mm	495x1040x495			
Net/gross weight	kg	51/57	54/60	53/59	
Water circuit	Piping connections	mm		DN25	
	Safety valve set pressure	MPa		0.3	
	Total water volume	L		5.0 / 5.5	
	Drainage pipe	mm		Φ16	
	Expansion tank	Volume	L		5
		Max. water pressure	MPa		0.8
		Pre pressure	MPa		0.15
	Water side heat exchanger	Type	Plate		
Volume		L	0.7	1 / 1	
Water pump head	m	6	7.5	7.5	
Refrigerant circuit	Liquid side	mm		Φ9.5	
	Gas side	mm		Φ15.9	
Backup electric heater	Size	kW		3.0 / 3.0 / 4.5	
	Step			2 / 2 / 2	
	Power supply			220-240/1/50 / 220-240/1/50 / 380-415/3/50	

Note: 1. Testing standard: EN12102-1.

Operating Limits

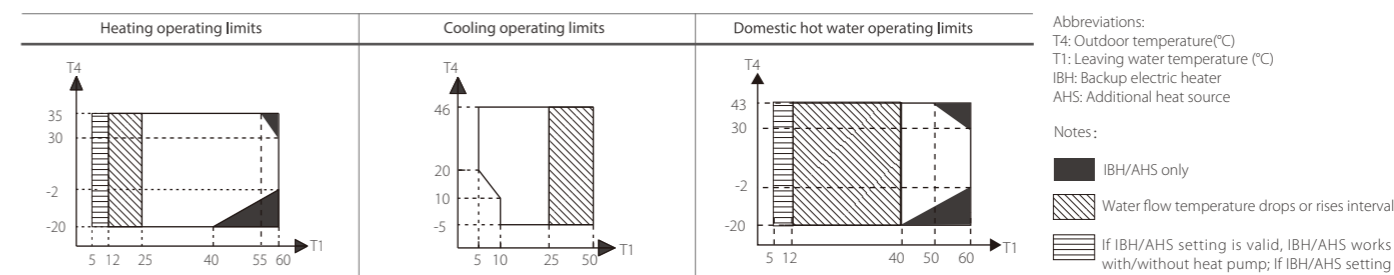

E Series Mono



Model MHC-			V5W/D2N8	V7W/D2N8	V9W/D2N8	V12W/D2N8	V14W/D2N8	V16W/D2N8	V12W/D2RN8	V14W/D2RN8	V16W/D2RN8
Power supply			220-240/1/50			220-240/1/50			380-415/3/50		
Heating ¹	Capacity	kW	4.65	6.65	8.60	12.30	14.10	16.30	12.30	14.10	16.30
	Rated input	kW	0.93	1.35	1.87	2.56	3.07	3.66	2.54	3.05	3.63
	COP		5.00	4.94	4.60	4.81	4.60	4.45	4.84	4.63	4.49
Heating ²	Capacity	kW	4.80	6.70	8.60	12.40	14.10	16.20	12.40	14.10	16.20
	Rated input	kW	1.33	1.88	2.50	3.52	4.06	4.72	3.45	3.99	4.70
	COP		3.60	3.57	3.44	3.53	3.47	3.43	3.59	3.54	3.45
Heating ³	Capacity	kW	4.65	6.80	8.60	11.90	14.20	16.10	11.90	14.20	16.10
	Rated input	kW	1.77	2.42	3.13	4.28	5.17	5.91	4.24	5.10	5.83
	COP		2.63	2.81	2.75	2.78	2.75	2.73	2.81	2.79	2.76
Cooling ⁴	Capacity	kW	4.60	6.45	8.00	12.20	14.00	15.50	12.20	14.00	15.50
	Rated input	kW	0.95	1.39	1.92	2.55	3.10	3.64	2.53	3.11	3.63
	EER		4.82	4.65	4.16	4.78	4.52	4.26	4.83	4.50	4.27
Cooling ⁵	Capacity	kW	4.85	6.30	7.95	10.90	12.90	13.80	10.90	12.90	13.80
	Rated input	kW	1.63	2.27	3.15	3.74	4.62	5.21	3.72	4.62	5.19
	EER		2.98	2.77	2.53	2.92	2.80	2.65	2.93	2.80	2.66
Seasonal space heating energy efficiency class ⁶	LWT at 35°C	class	A+++	A+++	A+++	A++	A++	A++	A++	A++	A++
	LWT at 55°C	class	A++	A++	A++	A++	A++	A++	A++	A++	A++
Air flow		m ³ /h	3050	3050	3050	6150	6150	6150	6150	6150	6150
Sound power level ⁷		dB	61	64	67	68	71	71	68	71	71
Net dimensions (WxHxD)		mm	1210x945x402			1404x1414x405			1404x1414x405		
Packed dimension (WxHxD)		mm	1285x1090x435			1430x1475x450			1430x1475x450		
Net/Gross weight		kg	92/111			158/178			172/193		
Water piping connections Dia.		inch	1" Male BSP			1-1/4" Male BSP			1-1/4" Male BSP		
Safety valve set pressure		MPa	0.3	0.3	0.3	0.3	0.3	0.3	0.3	0.3	0.3
Expansion tank volume		L	2	2	2	5	5	5	5	5	5
Total water volume		L	2	2	2	3.2	3.2	3.2	3.2	3.2	3.2
Ambient temperature range	Cooling	°C	-5-43			-5-46			-5-46		
	Heating	°C	-25-35			-25-35			-25-35		
	DHW	°C	-25-43			-25-43			-25-43		
LWT range	Cooling	°C	5-25			5-25			5-25		
	Heating	°C	25-60			25-60			25-60		
	DHW	°C	40-60			40-60			40-60		
Refrigerant	Type		R32			R32			R32		
	Charged volume	kg	2.0			2.8			2.8		
Throttle type			Electronic expansion valve			Electronic expansion valve			Electronic expansion valve		
Backup electric heater ⁸	Standard mounted	kW	/	/	/	/	/	/	/	/	/
	Optional	kW	3	3	3	3	3	3	4.5	4.5	4.5
	Capacity steps		1	1	1	1	1	1	1	1	1

Notes:

1. Evaporator air in 7°C, 85% RH., Condenser water in/out 30/35°C
2. Evaporator air in 7°C, 85% RH., Condenser water in/out 40/45°C
3. Evaporator air in 7°C, 85% RH., Condenser water in/out 47/55°C
4. Condenser air in 35°C. Evaporator water in/out 23/18°C
5. Condenser air in 35°C. Evaporator water in/out 12/7°C
6. Seasonal space heating energy efficiency class testes in average climate general conditions.
7. Testing standard: EN12102-1
8. For 5/7/9kW model, the backup electric heater is installed in an optional external box which model is BH30A while backup electric heater is built into 12/14/16kW model.
9. Relevant EU standards and legislation: EN14511; EN14825; EN50564; EN12102; (EU) No 811/2013; (EU) No 813/2013; OJ 2014/C 207/02:2014.

Operating Limits

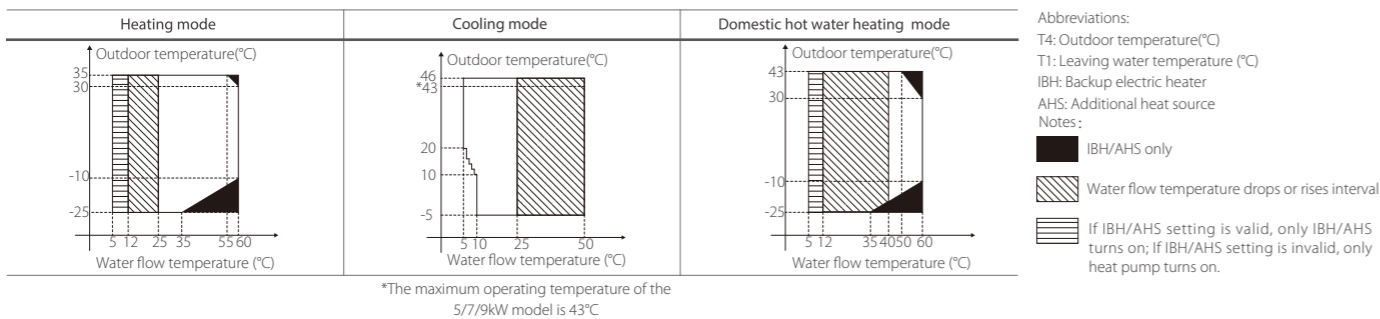

E Series Split outdoor unit



Model MHA-			V4W/D2N8		V6W/D2N8		V8W/D2N8		V10W/D2N8	
Hydronic box			Without water tank	With water tank	Without water tank	With water tank	Without water tank	With water tank	Without water tank	With water tank
Power supply			220-240/1/50							
Heating ¹	Capacity	kW	4.2	4.49	6.5	6.32	8.4	8.37	10	10.26
	Rated input	kW	0.82	0.9	1.34	1.32	1.73	1.72	2.15	2.19
	COP		5.15	5.01	4.85	4.79	4.85	4.87	4.65	4.68
Heating ²	Capacity	kW	4.2	4.14	6.35	6.09	8.05	8.02	9.85	10.3
	Rated input	kW	1.15	1.12	1.74	1.66	2.16	2.1	2.72	2.81
	COP		3.65	3.7	3.64	3.66	3.73	3.82	3.62	3.67
Heating ³	Capacity	kW	4.1	4.09	5.75	5.46	7.5	7.6	9.3	8.99
	Rated input	kW	1.44	1.44	1.98	1.82	2.49	2.44	3.25	2.98
	COP		2.85	2.84	2.9	3	3.01	3.12	2.86	3.02
Cooling ⁴	Capacity	kW	4.3	4.63	6.45	6.79	8.35	8.53	10.2	9.73
	Rated input	kW	0.77	0.89	1.32	1.32	1.79	1.71	2.4	2
	EER		5.6	5.21	4.88	5.14	4.67	5	4.25	4.87
Cooling ⁵	Capacity	kW	4.5	4.56	6.5	6.17	7.38	7.39	8.15	9.06
	Rated input	kW	1.36	1.31	2.2	1.92	2.44	2.37	2.76	3.01
	EER		3.32	3.48	2.95	3.21	3.02	3.12	2.95	3.01
Seasonal space heating energy efficiency class ⁶	Water outlet at 35°C	class	A+++	A+++	A+++	A+++	A+++	A+++	A+++	A+++
	Water outlet at 55°C	class	A++	A++	A++	A++	A++	A++	A++	A++
Water tank profile & DHW energy class	190L	L	/	A+	/	A+	/	A+	/	A+
	250L	XL	/	A	/	A	/	A	/	A
Sound power level ⁷		dB	61		62		63		65	
Net dimension (WxHxD)		mm	960x860x380				1075x965x395			
Packed dimension (WxHxD)		mm	1040x1000x430				1120x1100x435			
Net/Gross weight		kg	57/68				67/79			
Compressor	Type		Twin rotary invert				Twin rotary invert			
Outdoor fan	Motor type		DC Brushless fan				DC Brushless fan			
	Air flow	m ³ /h	3250				4950			
Air side heat exchanger	Type		Fin-coil							
Pipe size O.D.	Liquid	mm	6.35				9.52			
	Gas	mm	15.9				15.9			
	Connection method		Flared							
Between indoor and outdoor unit	Height difference	m	Max.20				Max.20			
	Pipe length	m	2-30				2-30			
Refrigerant	Type(GWP)		R32(675)							
	Charged volume	kg	1.55				1.65			
Additional refrigerant	Chargment	g/m	20				38			
	Min. pipe length	m	15							
Throttle type			Electronic expansion valve							
Outdoor air temperature range	Cooling	°C	-5~43							
	Heating	°C	-25~35							
	DHW	°C	-25~43							

1. Evaporator air in 7°C, 85% RH., Condenser water in/out 30/35°C
2. Evaporator air in 7°C, 85% RH., Condenser water in/out 40/45°C
3. Evaporator air in 7°C, 85% RH., Condenser water in/out 47/55°C
4. Condenser air in 35°C. Evaporator water in/out 23/18°C
5. Condenser air in 35°C. Evaporator water in/out 12/7°C
6. Seasonal space heating energy efficiency class testes in average climate general
7. Testing standard: EN12102-1
8. Relevant EU standards and legislation: EN14511; EN14825; EN50564; EN12102; (EU) No 811/2013; (EU) No 813/2013; OJ 2014/C 207/02:2014.

E Series Split hydronic box



Hydronic box		Model		SMK-60/CGN8	SMK-80/CGN8
		Compatible outdoor unit model MHA-		V4(6)W/D2N8	V8(10)W/D2N8
LWT range	Space heating	Low	°C	25 to 55	25 to 55
		High	°C	35 to 60	35 to 60
	Space cooling	Low	°C	5 to 25	5 to 25
		High	°C	18 to 25	18 to 25
DHW			°C	40 to 60	40 to 60
Power supply		V/Ph/Hz		220-240/1/50	220-240/1/50
Sound power level ¹		dB		43	43
Net dimension (WxHxD)		mm		400x850x427	400x850x427
Packed dimension (WxHxD)		mm		495x1040x495	495x1040x495
Net/Gross weight		kg		47/53	47/53
Water side heat exchanger				Plate type	Plate type
Water tank size		L		/	/
Water tank heat exchanger	Coil material			/	/
	Coil diameter	mm		/	/
	Coil area	m ²		/	/
Water pump	Max. pump head	m		8.5	8.5
Expansion vessel (Primary circuit)	Volume	L		5	5
	Charge pressure	MPa		0.15	0.15
Connection	Outlet connect to terminals	inch		1"	1"
	Inlet connect to terminals	inch		1"	1"
	DHW outlet	inch		/	/
	Water inlet	inch		/	/
	DHW recirculation circuit inlet	inch		/	/
	Refrigerant liquid	mm		6.35	9.52
	Refrigerant gas	mm		15.88	15.88
Safety valve		MPa		0.3	0.3
Flow switch		m ³ /h		0.6	0.6
Backup E-heater	Standard mounted	kW		/	/
	Optional	kW		3	3
	Power supply	V/Ph/Hz		220-240/1/50	220-240/1/50
Water tank E-heater	Capacity mounted	kW		/	/
	Power supply	V/Ph/Hz		/	/

Note: 1. Testing standard: EN12102-1.

Operating Limits

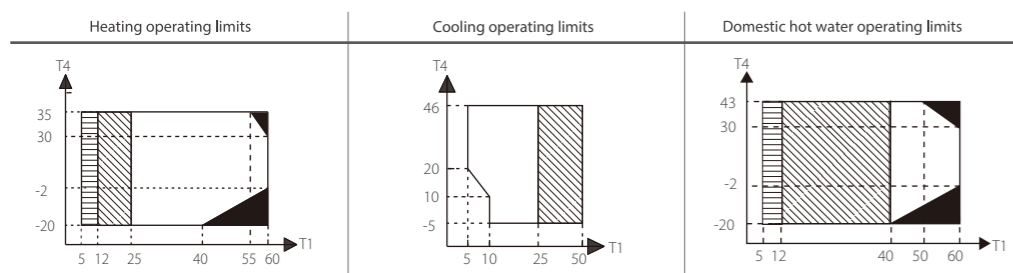

Abbreviations:
 T4: Outdoor temperature(°C)
 T1: Leaving water temperature (°C)
 IBH: Backup electric heater
 AHS: Additional heat source

Notes:
 ■ IBH/AHS only
 ▨ Water flow temperature drops or rises interval
 ▨ If IBH/AHS setting is valid, only IBH/AHS turns on; if IBH/AHS setting is invalid, only heat pump turns on.

A Series Mono



Outdoor unit model MHC-		V4W/ D2N8-B	V6W/ D2N8-B	V8W/ D2N8-B	V10W/ D2N8-B	V12W/ D2N8-B	V14W/ D2N8-B	V16W/ D2N8-B	V12W/ D2RN8-B	V14W/ D2RN8-B	V16W/ D2RN8-B		
Power supply		V/Ph/Hz 220-240/1/50						380-415/3/50					
Heating ¹	Capacity	kW	4.20	6.35	8.40	10.0	12.1	14.5	15.9	12.1	14.5	15.9	
	Rated input	kW	0.82	1.28	1.63	2.02	2.44	3.15	3.53	2.44	3.15	3.53	
COP			5.10	4.95	5.15	4.95	4.95	4.60	4.50	4.95	4.60	4.50	
Heating ²	Capacity	kW	4.30	6.30	8.10	10.0	12.3	14.1	16.0	12.3	14.1	16.0	
	Rated input	kW	1.13	1.70	2.10	2.67	3.32	3.92	4.57	3.32	3.92	4.57	
COP			3.80	3.70	3.85	3.75	3.70	3.60	3.50	3.70	3.60	3.50	
Heating ³	Capacity	kW	4.40	6.00	7.50	9.50	11.9	13.8	16.0	11.9	13.8	16.0	
	Rated input	kW	1.49	2.03	2.36	3.06	3.90	4.68	5.61	3.90	4.68	5.61	
COP			2.95	2.95	3.18	3.10	3.05	2.95	2.85	3.05	2.95	2.85	
Cooling ⁴	Capacity	kW	4.50	6.50	8.30	9.90	12.00	13.50	14.90	12.00	13.50	14.90	
	Rated input	kW	0.82	1.35	1.64	2.18	3.04	3.75	4.38	3.04	3.75	4.38	
EER			5.50	4.80	5.05	4.55	3.95	3.60	3.40	3.95	3.60	3.40	
Cooling ⁵	Capacity	kW	4.70	7.00	7.45	8.20	11.5	12.4	14.0	11.5	12.4	14.0	
	Rated input	kW	1.36	2.33	2.22	2.52	4.18	4.96	5.60	4.18	4.96	5.60	
EER			3.45	3.00	3.35	3.25	2.75	2.50	2.50	2.75	2.50	2.50	
Seasonal space heating energy efficiency class ⁶	Water outlet at 35°C	class	A+++										
	Water outlet at 55°C	class	A++										
Refrigerant	Type(GWP)		R32(675)										
	Charged volume	kg	1.40			1.40			1.75			1.75	
Sound power level ⁷	dB	55	58	59	60	65	65	68	65	65	68		
Unit dimension (WxHxD)	mm	1295x792x429						1385x945x526					
Packing dimension (WxHxD)	mm	1375x965x475						1465x1120x560					
Net/Gross weight	kg	98/121		121/148			144/170			160/188			
Outdoor air temperature range	Cooling	°C	-5~43										
	Heating	°C	-25~35										
	DHW	°C	-25~43										
Water side heat exchanger		Plate type											
Water pump	Max. pump head	m	9										
Water side connection	mm	R1"			R5/4"								
Backup E-heater ⁸	Standard mounted	kW	/										
	Optional	kW	3	3	3/9	3/9	3/9	3/9	3/9	3/9	3/9	3/9	
	Capacity steps		1	1	1/3	1/3	1/3	1/3	1/3	1/3	1/3	1/3	
	Power supply	3kW 9kW	V/Ph/Hz 220-240/1/50						380-415/3/50				
Water outlet temperature range	Cooling	°C	5~25										
	Heating	°C	25~65										
	DHW (tank)	°C	30~60										

Notes:

- Evaporator air in 7°C, 85% R.H., Condenser water in/out 30/35°C
- Evaporator air in 7°C, 85% R.H., Condenser water in/out 40/45°C
- Evaporator air in 7°C, 85% R.H., Condenser water in/out 47/55°C
- Condenser air in 35°C. Evaporator water in/out 23/18°C
- Condenser air in 35°C. Evaporator water in/out 12/7°C
- Seasonal space heating energy efficiency class testes in average climate general conditions.
- Testing standard: EN12102-1.
- Backup electric heater is built into all models. For three phase type backup electric heater, 3/6kW can be achieved by changing DIP switch when heat pump is equipped with 9kW.
- Relevant EU standards and legislation: EN14511; EN14825; EN50564; EN12102; (EU) No 811/2013; (EU) No 813/2013; OJ 2014/C 207/02:2014.

Operating Limits

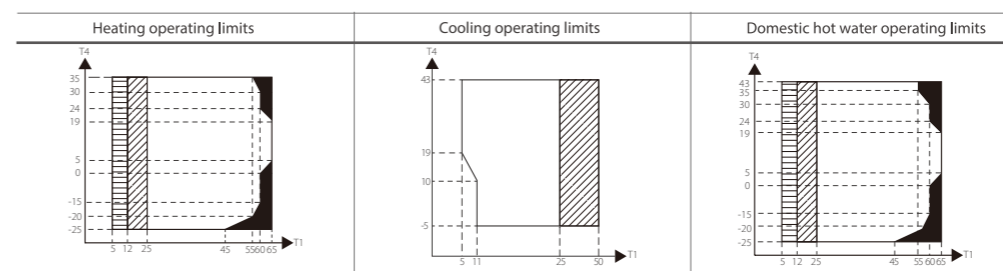

Abbreviations:
 T4: Outdoor temperature(°C)
 T1: Leaving water temperature (°C)
 IBH: Backup electric heater
 AHS: Additional heat source

Notes:
 ■ IBH/AHS only
 ▨ Water flow temperature drops or rises interval
 ▨ If IBH/AHS setting is valid, only IBH/AHS turns on; if IBH/AHS setting is invalid, only heat pump turns on.

A Series Mono



Model		MHC-V18W/D2RN8	MHC-V22W/D2RN8	MHC-V26W/D2RN8	MHC-V30W/D2RN8	
Power supply		V/Ph/Hz 380-415/3/50				
Heating ¹	Capacity	kW	18.00	22.00	26.00	30.10
	Rated input	kW	3.83	5.00	6.37	7.70
	COP		4.70	4.40	4.08	3.91
Heating ²	Capacity	kW	18.00	22.00	26.00	30.00
	Rated input	kW	5.14	6.47	8.39	10.35
	COP		3.50	3.40	3.10	2.90
Heating ³	Capacity	kW	18.00	22.00	26.00	30.00
	Rated input	kW	6.55	8.30	10.61	13.04
	COP		2.75	2.65	2.45	2.30
Cooling ⁴	Capacity	kW	18.50	23.00	27.00	31.00
	Rated input	kW	3.90	5.00	6.28	7.75
	EER		4.75	4.60	4.30	4.00
Cooling ⁵	Capacity	kW	17.00	21.00	26.00	29.50
	Rated input	kW	5.57	7.12	9.63	11.57
	EER		3.05	2.95	2.70	2.55
Seasonal space heating energy efficiency class ⁶	Water outlet at 35°C	class	A+++	A+++	A+++	A++
	Water outlet at 55°C	class	A++	A++	A+	A+
Refrigerant	Type(GWP)		R32(675)			
	Charged volume		5.0			
Sound power level ⁷		dB	71	73	75	77
Unit dimension (WxHxD)		mm	1129x1558x440			
Packing dimension (WxHxD)		mm	1220x1735x565			
Net/Gross weight			177/206			
Water side heat exchanger			Plate type			
Water pump	Max. pump head	m	12.0	12.0	12.0	12.0
Water piping connections Dia.		inch	1-1/4" BSP	1-1/4" BSP	1-1/4" BSP	1-1/4" BSP
Ambient temperature range	Cooling	°C	-5-46			
	Heating	°C	-25-35			
	DHW	°C	-25-43			
Water outlet temperature range	Cooling	°C	5-25			
	Heating	°C	25-60			
	DHW	°C	30-60			

Notes:

1. Evaporator air in 7°C, 85% R.H., Condenser water in/out 30/35°C.
2. Evaporator air in 7°C, 85% R.H., Condenser water in/out 40/45°C.
3. Evaporator air in 7°C, 85% R.H., Condenser water in/out 47/55°C.
4. Condenser air in 35°C. Evaporator water in/out 23/18°C.
5. Condenser air in 35°C. Evaporator water in/out 12/7°C.
6. Seasonal space heating energy efficiency class testes in average climate general.
7. Testing standard: EN12102-1.
8. Relevant EU standards and legislation: EN14511; EN14825; EN50564; EN12102; (EU) No 811/2013; (EU) No 813/2013; OJ 2014/C 207/02:2014.

Operating Limits

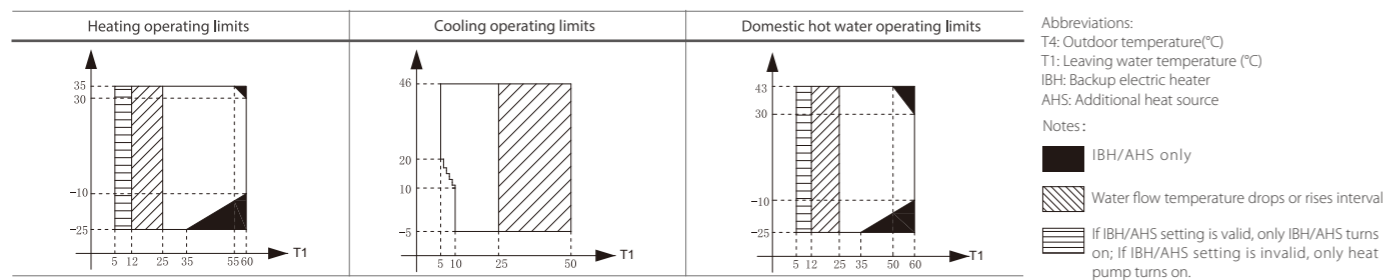

A Series Split

Outdoor unit model MHA-		V4W/D2N8-B	V6W/D2N8-B	V8W/D2N8-B	V10W/D2N8-B	V12W/D2N8-B	V14W/D2N8-B	V16W/D2N8-B	V12W/D2RN8-B	V14W/D2RN8-B	V16W/D2RN8-B	
Hydronic box model HB-A		60/CGN8-B			100/CGN8-B			160/CGN8-B				
Heating ¹	Capacity	kW	4.25	6.20	8.30	10.0	12.1	14.5	16.0	12.1	14.5	16.0
	Rated input	kW	0.82	1.24	1.60	2.00	2.44	3.09	3.56	2.44	3.09	3.56
	COP		5.20	5.00	5.20	5.00	4.95	4.70	4.50	4.95	4.70	4.50
Heating ²	Capacity	kW	4.35	6.35	8.20	10.0	12.3	14.2	16.0	12.3	14.2	16.0
	Rated input	kW	1.14	1.69	2.08	2.63	3.24	3.89	4.44	3.24	3.89	4.44
	COP		3.80	3.75	3.95	3.80	3.80	3.65	3.60	3.80	3.65	3.60
Heating ³	Capacity	kW	4.40	6.00	7.50	9.50	12.0	13.8	16.0	12.0	13.8	16.0
	Rated input	kW	1.49	2.00	2.36	3.06	3.87	4.60	5.52	3.87	4.60	5.52
	COP		2.95	3.00	3.18	3.10	3.10	3.00	2.90	3.10	3.00	2.90
Cooling ⁴	Capacity	kW	4.50	6.55	8.40	10.00	12.00	13.50	14.90	12.00	13.50	14.90
	Rated input	kW	0.81	1.34	1.66	2.08	3.00	3.75	4.38	3.00	3.75	4.38
	EER		5.55	4.90	5.05	4.80	4.00	3.60	3.40	4.00	3.60	3.40
Cooling ⁵	Capacity	kW	4.70	7.00	7.40	8.20	11.6	12.7	14.0	11.6	12.7	14.0
	Rated input	kW	1.36	2.33	2.19	2.48	4.22	4.98	5.71	4.22	4.98	5.71
	EER		3.45	3.00	3.38	3.30	2.75	2.55	2.45	2.75	2.55	2.45
Seasonal space heating energy efficiency class ⁶	Water outlet at 35°C	class	A+++									
	Water outlet at 55°C	class	A++									

Notes:

1. Evaporator air in 7°C, 85% R.H., Condenser water in/out 30/35°C
2. Evaporator air in 7°C, 85% R.H., Condenser water in/out 40/45°C
3. Evaporator air in 7°C, 85% R.H., Condenser water in/out 47/55°C
4. Condenser air in 35°C. Evaporator water in/out 23/18°C
5. Condenser air in 35°C. Evaporator water in/out 12/7°C
6. Seasonal space heating energy efficiency class testes in average climate general conditions.
7. Relevant EU standards and legislation: EN14511; EN14825; EN50564; EN12102; (EU) No 811/2013; (EU) No 813/2013; OJ 2014/C 207/02:2014.

A Series Split outdoor unit



Outdoor unit model MHA-		V4W/D2N8-B	V6W/D2N8-B	V8W/D2N8-B	V10W/D2N8-B	V12W/D2N8-B	V14W/D2N8-B	V16W/D2N8-B	V12W/D2RN8-B	V14W/D2RN8-B	V16W/D2RN8-B	
Power supply		V/Ph/Hz		220-240/1/50				380-415/3/50				
Compressor	Type	Twin rotary										
Outdoor fan	Motor type	DC fan										
	Number of fans	1										
Air side heat exchanger	Type	Fin-coil										
Refrigerant	Type(GWP)	R32(675)										
	Charged volume	kg	1.50	1.65				1.84				
Throttle type		Electronic expansion valve										
Sound power Level ¹	dB	56	58	59	60	64	65	68	64	65	68	
Unit dimension (WxHxD)	mm	1008x712x426				1118x865x523						
Packing dimension (WxHxD)	mm	1065x800x485				1180x890x560						
Net/Gross weight	kg	58/64		77/88			96/110		112/125			
Pipe size O.D.	Liquid	mm		6.35		9.52						
	Gas	mm		15.88		15.88						
Connection method		Flared										
Between indoor and outdoor unit	Height difference	m										
	Pipe length	m										
Additional refrigerant	Chargment	g/m		20		38						
	Max. pipe length for no additional refrigerant	m										
Outdoor air temperature range	Cooling	°C										
	Heating	°C										
	DHW	°C										

Note: 1. Testing standard: EN12102-1.

A Series Split hydronic box



Hydronic box model HB-A		60/CGN8-B	100/CGN8-B	160/CGN8-B
Power supply	V/Ph/Hz	220-240/1/50		
Sound power level ¹	dB	38	42	43
Unit dimension (WxHxD)	mm	420x790x270		
Packing dimension (WxHxD)	mm	525x1050x360		
Net/Gross weight	kg	37/43		39/45
Water side heat exchanger		Plate type		
Water pump	Max. pump head	m		
Expansion vessel	Volume	L		
(Primary circuit)	Charge pressure	MPa		
Connection	water side	mm		
	Refrigerant liquid	mm	6.35	9.52
	Refrigerant gas	mm	15.88	15.88
Safety valve	MPa	0.3		
Flow switch	m ³ /h	0.36		0.6
Total water volume	L	5		
Backup E-heater ²	Standard mounted	kW		
	Optional	kW		
	Capacity steps	1/3		
	Power supply	3kW	V/Ph/Hz	
9kW		380-415/3/50		
Room temperature range	°C	5~35		
Water outlet temperature range	Cooling	°C		
	Heating	°C		
	DHW(tank)	°C		

Note: 1. Testing standard: EN12102-1.

2. For three phase type backup electric heater, 3/6kW can be achieved by changing DIP switch when hydronic box is equipped with 9kW.

Operating Limits

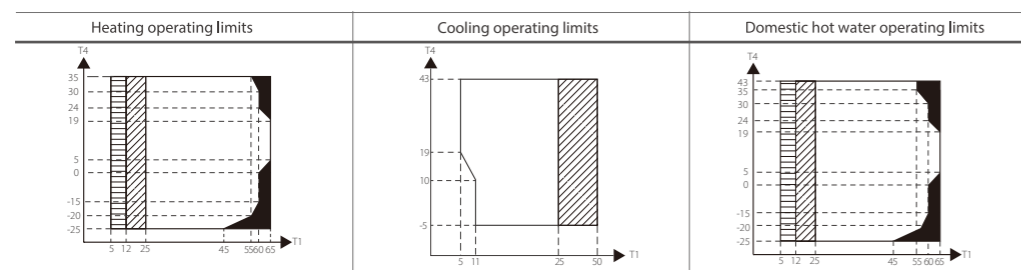

Abbreviations:
 T4: Outdoor temperature(°C)
 T1: Leaving water temperature (°C)
 IBH: Backup electric heater
 AHS: Additional heat source

Notes:
 ■ IBH/AHS only
 ▨ Water flow temperature drops or rises interval
 ▨ If IBH/AHS setting is valid, only IBH/AHS turns on; If IBH/AHS setting is invalid, only heat pump turns on.

Sanitary Hot Water



Sanitary Hot Water Combo Type



Nomenclature

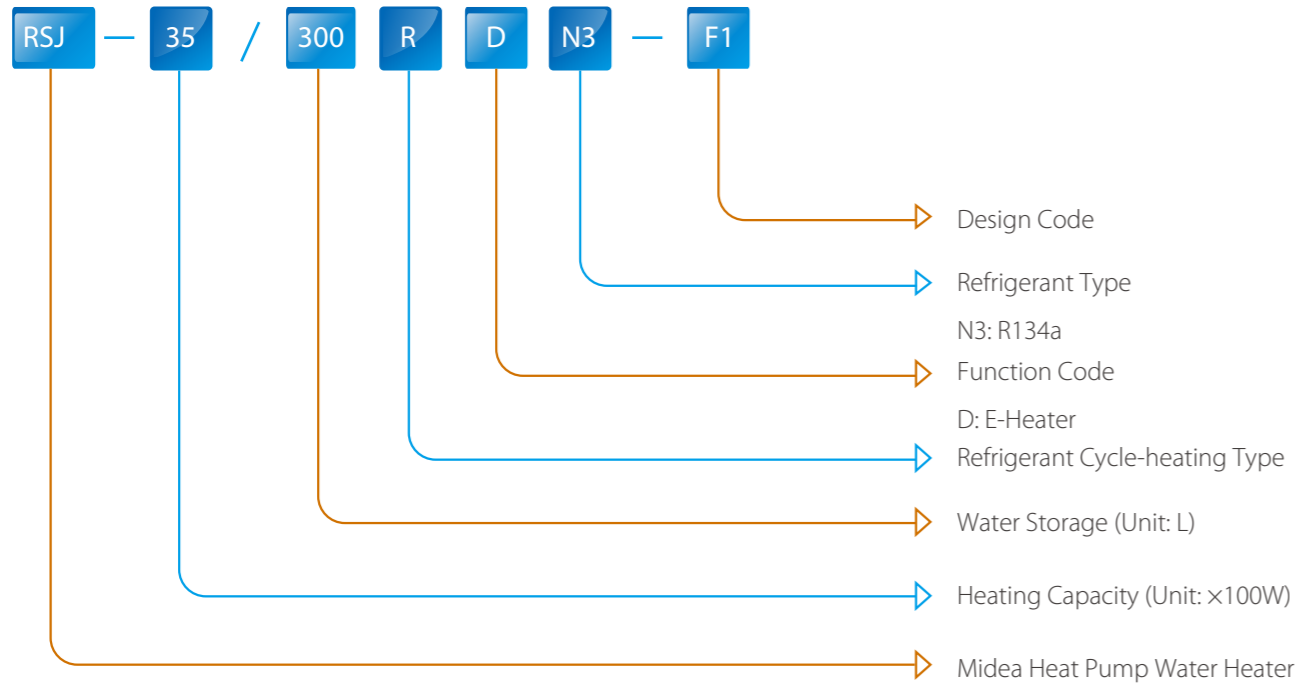

Features

Environmental protection

- ❖ Environmentally friendly refrigerant R134a is used.
- ❖ No discharge of poisonous gas.
- ❖ No pollution to atmosphere and environment.



High heating energy efficiency

The unit adopts heat pump principle, which absorbs heat from ambient air and releases it to the water to produce hot water. Seasonal water heating energy efficiency class ups to A.

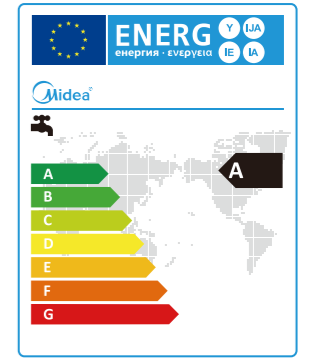

For RSJ-15/190RDN3-F, RSJ-35/300RDN3-F1

Features

- ❖ Enamel water tank, hardly be corroded.
- ❖ Complete isolation between water and electricity without electric shock problem.
- ❖ No fuel tubes and storage, no potential danger from oil leakage, fire, explosion, and so on.
- ❖ No cross contamination potential, the condenser coil is wrapped around the inner tank.
- ❖ Uniform water temperature provides more comfort for bottom coil and special distributary design.
- ❖ Sideward air flow design allows machine has better rainproof effect.
- ❖ Outside metal design prevents aging caused by strong light exposure (sideward air flow model).

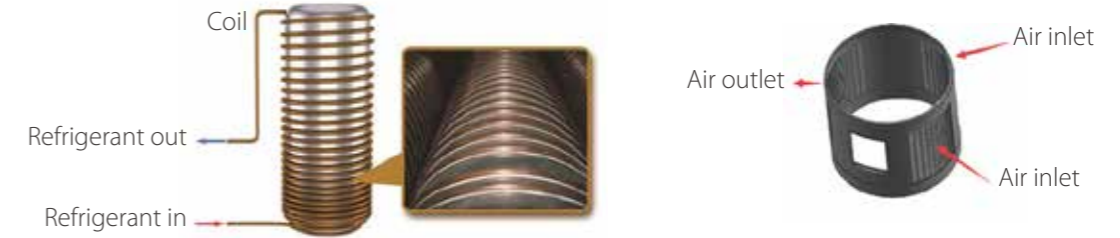

Easy installation

- ❖ Integral designed and just need to connect water pipes.
- ❖ 25Pa external static pressure enables air duct up to 10m (topside air flow model).
- ❖ Flexible duct installation (topside air flow model).



Easy control

Model	RSJ-15/190RDN3-F RSJ-35/300RDN3-F1	RSJ-15/190RDN3-E	RSJ-23/300RDN3-B
Controller appearance			
Main Functions	Protection alarm and buzzer prompt tone Button and screen auto lock Auto restart Timer function Combination button (Query, clear error code) E-heater, vocation and disinfect mode	Protection alarm and buzzer prompt tone Button and screen auto lock Auto restart Timer function Combination button (Query, clear error code) E-heater, economy and hybrid mode Disinfection	Protection alarm and buzzer prompt tone Button and screen auto lock Auto restart Timer function Combination button (Query, Disinfect, E-forced heating) E-heater, economy and hybrid mode Remote control



Combo Type 190L/300L

RSJ-15/190RD3-F
RSJ-35/300RD3-F1

- ❖ Running ambient temperature -20~43°C
- ❖ Water output temperature 38~70°C
- ❖ Multiple key LCD display panel
- ❖ Automatic weekly disinfect function
- ❖ Top air flow, 25Pa air flow pressure enables ducted length up to 10m
- ❖ A rated energy efficiency



Combo Type 190/300L

RSJ-15/190RD3-E
RSJ-23/300RD3-B

- ❖ Running ambient temperature -20~43°C
- ❖ Water output temperature 38~70°C
- ❖ Multiple key LCD display panel
- ❖ Automatic weekly disinfect function
- ❖ Sideward air flow
- ❖ Metal net design (For RSJ-23/300RD3-B)

Specifications

Model		RSJ-15/190RD3-F		RSJ-35/300RD3-F1	
Power supply	V/Ph/Hz	220-240/1/50		220-240/1/50	
Running mode		Economy	E-heater	Economy	E-heater
Running ambient temperature	°C	-7~43	-20~43	-7~43	-20~43
Output water temperature	°C	Default 60,38~70		Default 55,38~65	
Storage size ¹	Ltr	180		280	
Capacity ²	kW	1.45	3.15	3.00	3.00
COP		3.80	1.00	3.60	1.00
Max. current	A	17		18.7	
Water heating energy efficiency class		A		A	
Dimension (DxH)	mm	Φ560x1,760		Φ650x1,920	
Packing (WxHxD)	mm	695x1,805x685		740x2,160x770	
Net weight	kg	107		145.5	
Sound pressure level ³	dB(A)	42		45	
Sound power level	dB(A)	58		58	
Compressor	Type	Rotary		Rotary	
Fan motor	Type	AC Motor		AC Motor	
Air side heat exchanger	Type	Fin-coil		Fin-coil	
Water side heat exchanger	Type	Dividing wall type heat exchanger		Dividing wall type heat exchanger	
Refrigerant	Type/Quantity	R134a/1.0		R134a/1.2	
	Throttle type	Electric expansion valve		Electric expansion valve	
Water pipeline	Water inlet pipe	mm DN20		mm DN20	
	Water outlet pipe	mm DN20		mm DN20	
	Drainage pipe	mm DN20		mm DN20	
	PTR valve joint	mm DN20		mm DN20	
E-heater	kW	3.15		3.15	
Hot water yield ⁶	m ³ /h	0.041	/	0.086	/
Applicable persons		3~4		5~6	

Remark:

1. The storage size is labeled according to NF certification requirement.
2. The test conditions: outdoor temperature 15/12°C(DB/WB), initial water temperature in the units is 15°C, terminal water temperature is 45°C.
3. Sound pressure value test conditions: four side of the unit, distance is 1m, and height is 1m + half of the unit's height.
4. The above data test reference standard EN16147; (EU)No:812:2013; (EU)No:814:2013.
5. The specifications may be changed for product improvement without notice.
6. The value is calculated based on the capability value and capability test condition.

Specifications

Model		RSJ-15/190RD3-E		RSJ-23/300RD3-B	
Power supply	V/Ph/Hz	220-240/1/50		220-240/1/50	
Running mode		Economy	E-heater	Economy	E-heater
Running ambient temperature	°C	5~43	-20~43	-7~43	-20~43
Output water temperature	°C	Default 63, 38~70		Default 60,55~60	
Storage size	Ltr	170		280	
Capacity ¹	kW	1.50	2.15	2.00	3.00
COP		3.35	1.00	4.39	1.00
Max. current	A	12.1		17.3	
Dimension (DxH)	mm	Φ568x1,580		Φ650x1,936	
Packing (WxHxD)	mm	730x1675x700		740x2235x770	
Net weight	kg	92		153.5	
Sound pressure level ²	dB(A)	48		49	
Compressor	Type	Rotary		Rotary	
Fan motor	Type	AC Motor		AC Motor	
Air side heat exchanger	Type	Fin-coil		Fin-coil	
Water side heat exchanger	Type	Dividing wall type heat exchanger		Dividing wall type heat exchanger	
Refrigerant	Type/Quantity	R134a/0.8		R134a/1.6	
	Throttle type	Electric expansion valve		Electric expansion valve	
Water pipeline	Water inlet pipe	mm DN20		mm DN20	
	Water outlet pipe	mm DN20		mm DN20	
	Drainage pipe	mm DN20		mm DN20	
	PTR valve joint	mm DN20		mm DN20	
E-heater	kW	2.15		3	
Hot water yield ⁴	m ³ /h	0.043	/	0.058	/
Applicable persons		3~4		5~6	

Remark:

1. The test conditions: outdoor temperature 15/12°C(DB/WB), initial water temperature in the units is 15°C, terminal water temperature is 45°C.
2. Sound pressure value test conditions: four side of the unit, distance is 1m, and height is 1m + half of the unit's height.
3. The specifications may be changed for product improvement without notice.
4. The value is calculated based on the capability value and capability test condition.

Sanitary Hot Water Split Type



Nomenclature

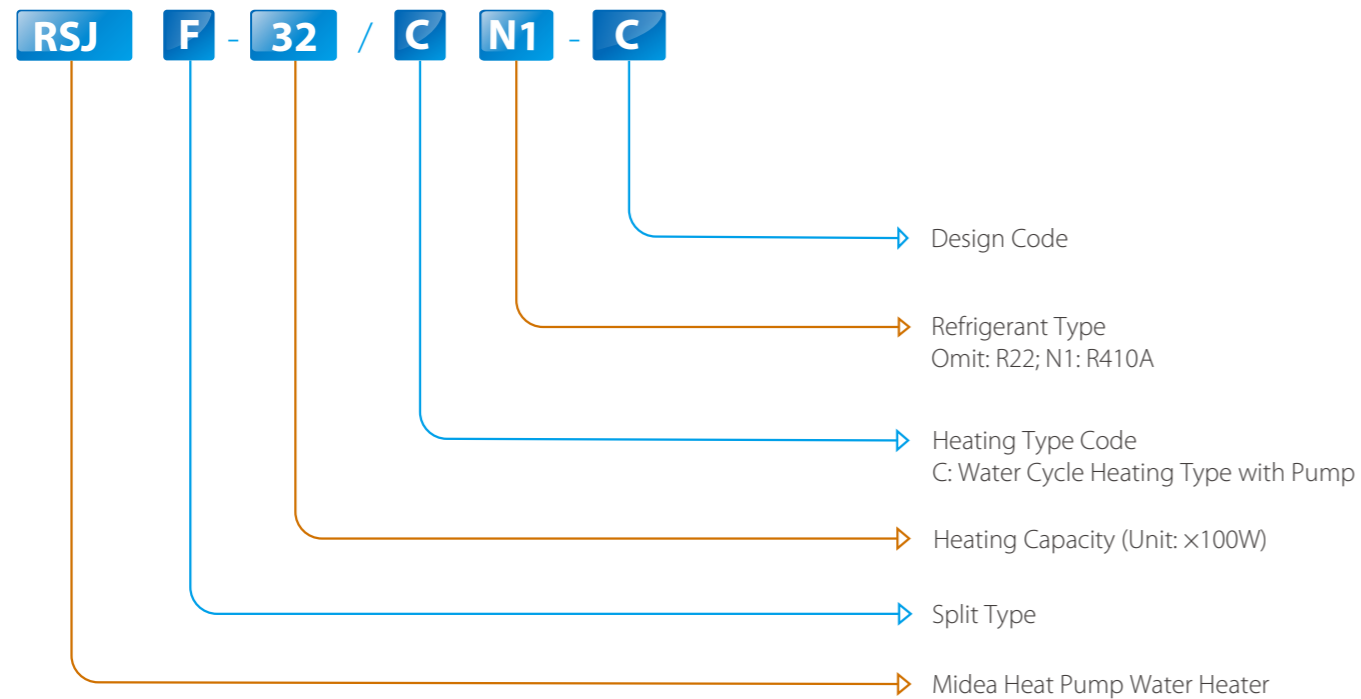

Features

- ❖ R410A refrigerant
- ❖ Max. water output temperature: 60°C
- ❖ Automatic startup and shutdown
- ❖ Four-way valve for automatic defrosting
- ❖ Sealed refrigerant circuit, easy for plumber installation
- ❖ Built-in water pump.
- ❖ Single-wall tube in tube heat exchanger



Wired Controller

- ❖ Touch key operation
- ❖ Parameter setting an LCD display
- ❖ Multiple timers
- ❖ Real-time clock function
- ❖ Power-off memory function



KJR-51/BMKE-A

Specifications

Model			RSJF-32/CN1-C	RSJF-50/CN1-C	RSJF-72/CN1-C
Power supply	V/Ph/Hz		220-240/1/50		
Running ambient temperature	°C		-7~43	-7~43	-7~43
Output water temperature	°C		Default 50°C, 40°C~60°C		
Water heating	Capacity	kW	3.00	4.30	6.50
	Input	kW	0.87	1.22	1.72
	COP		3.45	3.53	3.78
	Max. current	A	6.8	8.5	12.4
Dimension (WxHxD)	mm		790x765x275	790x765x275	845x945x335
Packing (WxHxD)	mm		905x807x355	905x807x355	965x1,009x395
Net/gross weight	kg		48/52	55/58	68.5/74
Outdoor noise level	dB(A)		53	55	55
Air flow	m³/h		2,000	2,000	3,200
Compressor	Type		Rotary		
Fan motor	Type		AC Motor		
Water side heat exchanger	Type		Single-wall heat exchanger		
Air side heat exchanger	Type		Fin-coil		
Water pump	Pump head	m	5.5	5.5	5.5
	Water volume	L/min	10	10	10
Refrigerant	Type/Quantity	kg	R410A/0.7	R410A/0.9	R410A/1.0
	Throttle type		Electric expansion valve		
Water pipeline	Water inlet pipe	mm	DN20	DN20	DN20
	Water outlet pipe	mm	DN20	DN20	DN20
Controller			KJR-51/BMKE-A		
Hot water yield ³	m³/h		0.516	0.74	1.12
Storage size of optional tank	L		100~250	150~300	250~500

Remark:
 1. The test conditions: outdoor temperature 7/6°C(DB/WB), inlet water temperature 30°C, outlet water temperature 35°C.
 2. The specifications may be changed for product improvement, please refer to the nameplate.
 3. The value is calculated based on the capability value and capability test condition.

Swimming Pool Application





Nomenclature

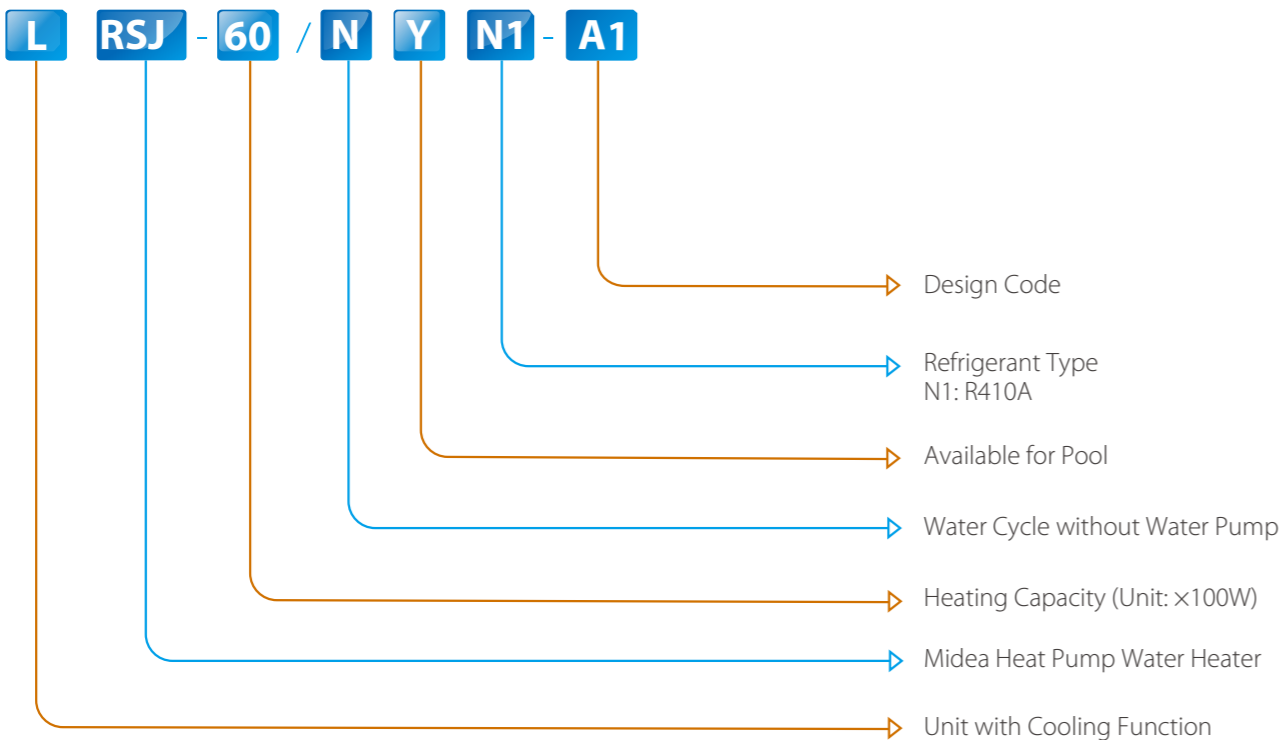

Features

- ❖ R410A refrigerant
- ❖ Max. water output temperature: 35°C
- ❖ Automatic defrosting function
- ❖ Automatic start-up and shut-down functions
- ❖ Heating, cooling and pump mode
- ❖ Anti-corrosion titanium heat exchanger

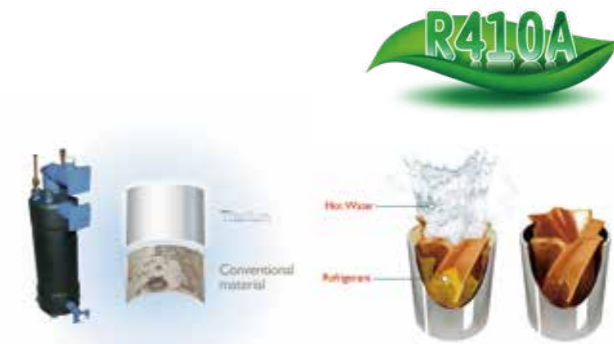

Anti-corrosion titanium heat exchanger

Wired Controller

- ❖ Mechanical button
- ❖ LCD displays operation parameters
- ❖ Indicator light
- ❖ Heating, cooling and pump mode



KJRH-90B/E

Specifications

Model		LRSJ-60/NYN1-A1	LRSJ-80/NYN1-A1	LRSJ-120/NYN1-A1	LRSJ-140/NYN1-A1	
Power supply	V/Ph/Hz	220-240/1/50				
Heating	Capacity	kW	6.00	8.00	11.70	13.60
	Input	kW	1.150	1.518	2.350	2.550
	COP		5.22	5.27	4.98	5.33
	Ambient temperature	°C	-7~38	-7~38	-7~38	-7~38
	Output water temperature	°C	Default 28°C, 20°C~35°C			
Cooling	Capacity	kW	4.00	5.80	8.25	10.35
	Input	kW	1.25	1.50	2.50	2.90
	EER		3.20	3.87	3.30	3.57
	Ambient temperature	°C	15~43	15~43	15~43	15~43
	Output water temperature	°C	Default 28°C, 10°C~30°C			
Max. current	A	6.3	8.3	14.4	16.0	
Dimension (WxHxD)	mm	1,015×705×385	1,015×705×385	1,050×855×315	1,050×855×315	
Packing (WxHxD)	mm	1,095×840×445	1,095×840×445	1,160×980×410	1,160×980×410	
Net/Gross weight	kg	58.5/67.5	66/75	75/85	75/85	
Outdoor noise level	dB(A)	58	58	58	58	
Compressor	Type	Rotary	Rotary	Rotary	Rotary	
Fan motor	Type	AC motor	AC motor	AC motor	AC motor	
Water side heat exchanger	Type	Titanium-tube	Titanium-tube	Titanium-tube	Titanium-tube	
Air side heat exchanger	Type	Fin-coil	Fin-coil	Fin-coil	Fin-coil	
Refrigerant	Type/Quantity	kg	R410A/1.0	R410A/1.25	R410A/1.6	R410A/1.85
	Throttle type		Capillary	Capillary	Capillary	Capillary
Water pipeline	Water inlet pipe	mm	Φ50	Φ50	Φ50	Φ50
	Water outlet pipe	mm	Φ50	Φ50	Φ50	Φ50
	Drainage pipe	mm	Φ25	Φ25	Φ25	Φ25
Wire controller			KJRH-90B/E	KJRH-90B/E	KJRH-90B/E	KJRH-90B/E
Applicable range	m ³	40	50	60~85	75~100	

Remark:
 1. The test conditions:
 Water Heating: outdoor temperature 24/19°C(DB/WB), inlet water temperature 27°C, outlet water temperature 29°C
 Water Cooling: outdoor temperature 35/24°C(DB/WB), inlet water temperature 27°C, the water flow volume is same in both cooling and heating mode.
 2. The specifications may be changed for product improvement, please refer to the nameplate.

Commercial Heat Pump Water Heater



Nomenclature

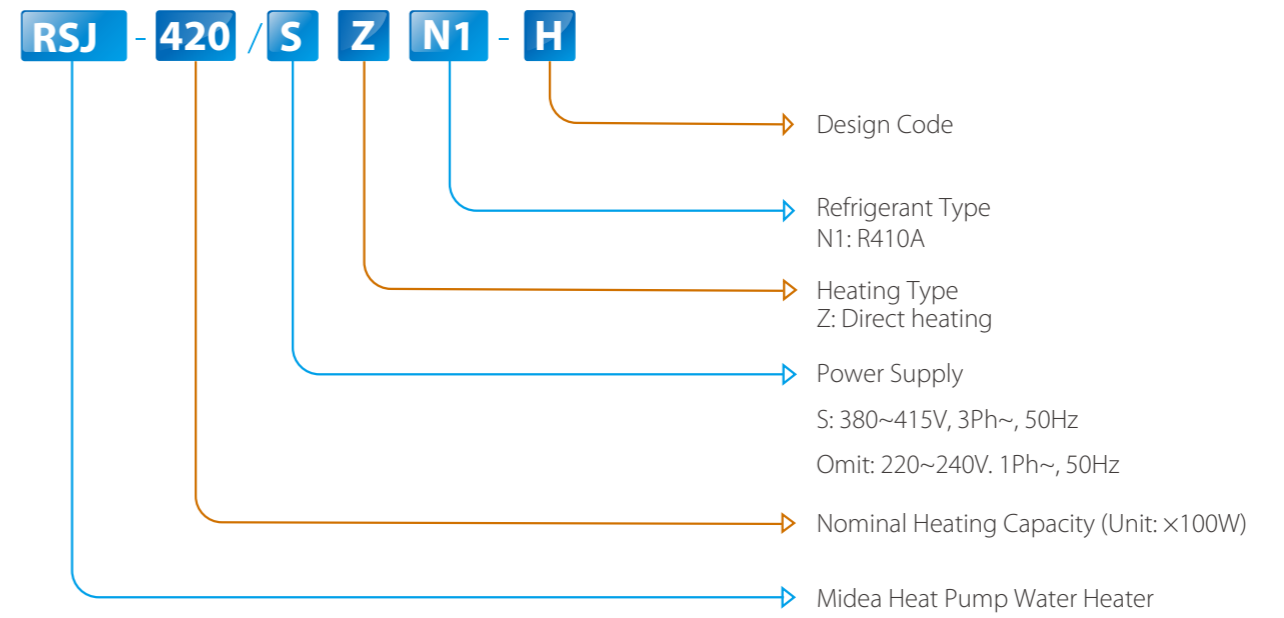

Product lineup

Capacity (kW)	12	20	42	80
Appearance Series				
220~240V-1Ph	●			
380~415V-3Ph		●	●	●

Features

Wide application range

- ❖ 4 basic models with heating capacity ranging from 12kW to 80kW.
- ❖ Free modular combination.

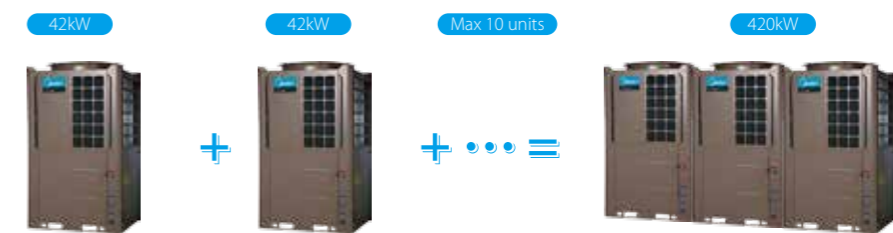

Easy control Wired controller



Model	KJR-51/BMKE-A
Appearance	
Main Functions	<ul style="list-style-type: none"> Touch key operation Parameter setting an LCD display Real-time clock function Multiple timer Power-off memory function Modbus(Customized)
Max. connection PCBs	16

Modbus function

Modbus is an open protocol that is widely used, especially in BMS building control systems. Modbus function can be customized by adding X, Y, E ports on wired controller KJR-51/BMKE-A. It can connect Max. 16 wired controllers and each controller can control Max. 16 units.

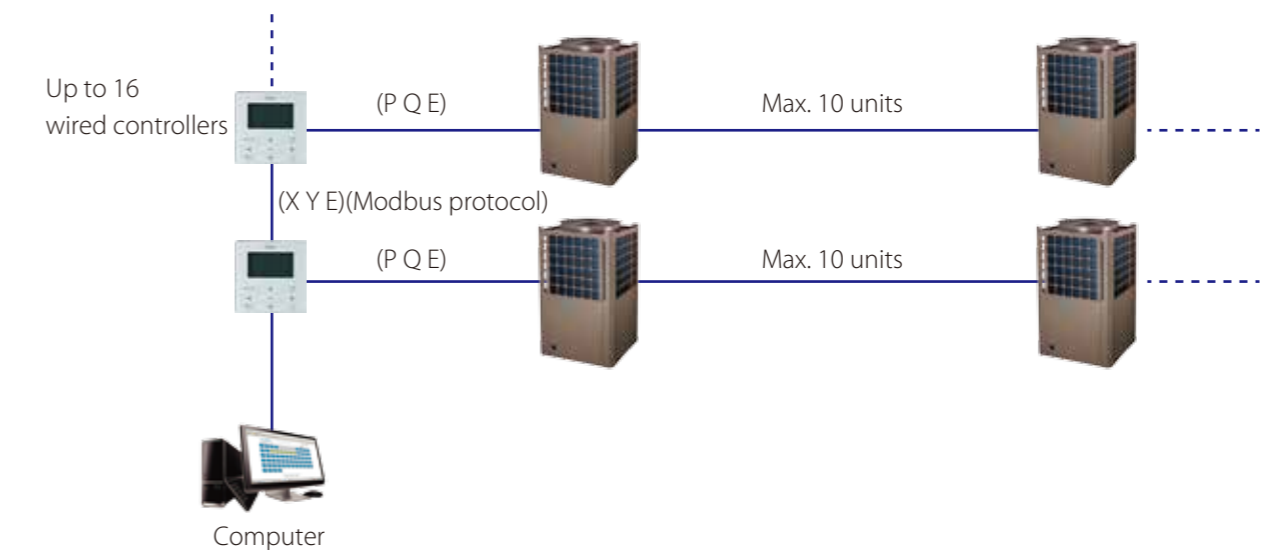

❖ Wide operation ambient temperature range.

Operates stably under extreme conditions, ranging from -15°C to 46°C.

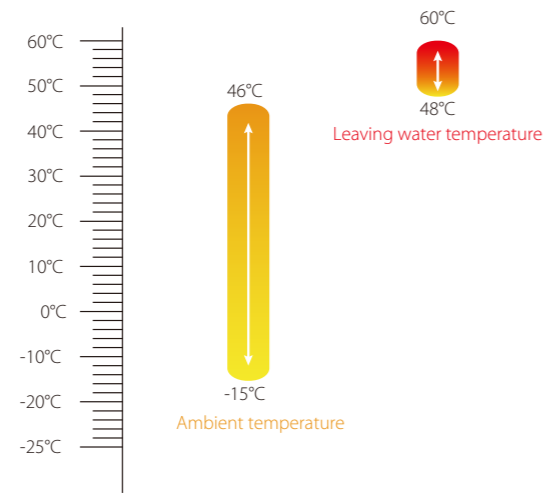

High heating energy efficiency

The unit adopts heat pump principle, which absorbs heat from ambient air and releases it to the water to produce hot water.

❖ High performance fin-coil type heat exchanger is adopted at air side.

The new designed window fins enlarge the heat-exchanging area, decrease the air resistance, save more power and enhance heat exchange performance.

Hydrophilic film fins and inner-threaded copper pipes optimize heat exchange efficiency.

The specially coated blue fins enhance durability and protect against corrosion from air, water and other corrosive agents, assures a longer coil service life.

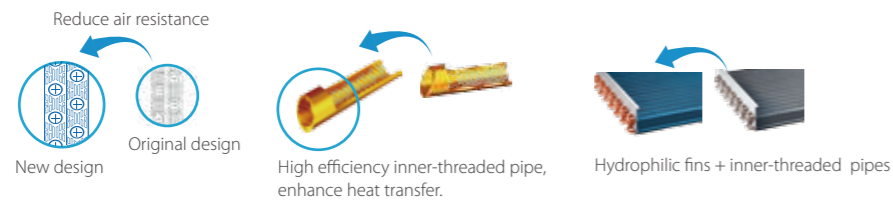

❖ High efficiency tube-in-tube heat exchanger

Inner grooved copper pipe, increase area of heat exchanger, improve efficient.

Anti-corrosion shell increases the useful life of heat exchanger.

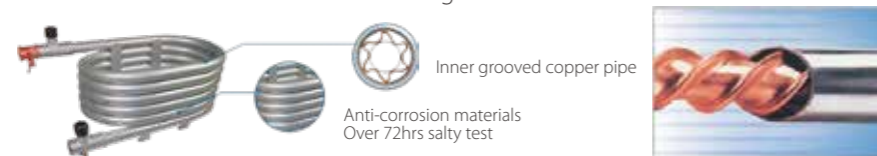

Advanced technology

❖ Unique defrosting flow path.

Air side reserved special defrosting flow path, when the system is defrosting, the four-way valve is reversing, the system will absorb energy from special defrosting flow path, the defrosting progress will have no impact on water temperature.

❖ Electric water flow valve supplies hot water at a stable temperature and expands the life of compressor.

❖ Optimized fan blade edge by CFD programs with analyzing air pressure distribution.

❖ G-shape fin-coil heat exchanger to optimize air flow system of unit.

Remote control functions for convenient operation.

There are ON/OFF, Heat/Cool and Alarm terminals ports on PCB, connect switches from these terminal ports and remote control functions can be easily realized.



Note: When use the remote control function, the wired controller will be invalid for OFF and mode selection.

Simple refrigerating system diagram

Parallel connected heat pump system

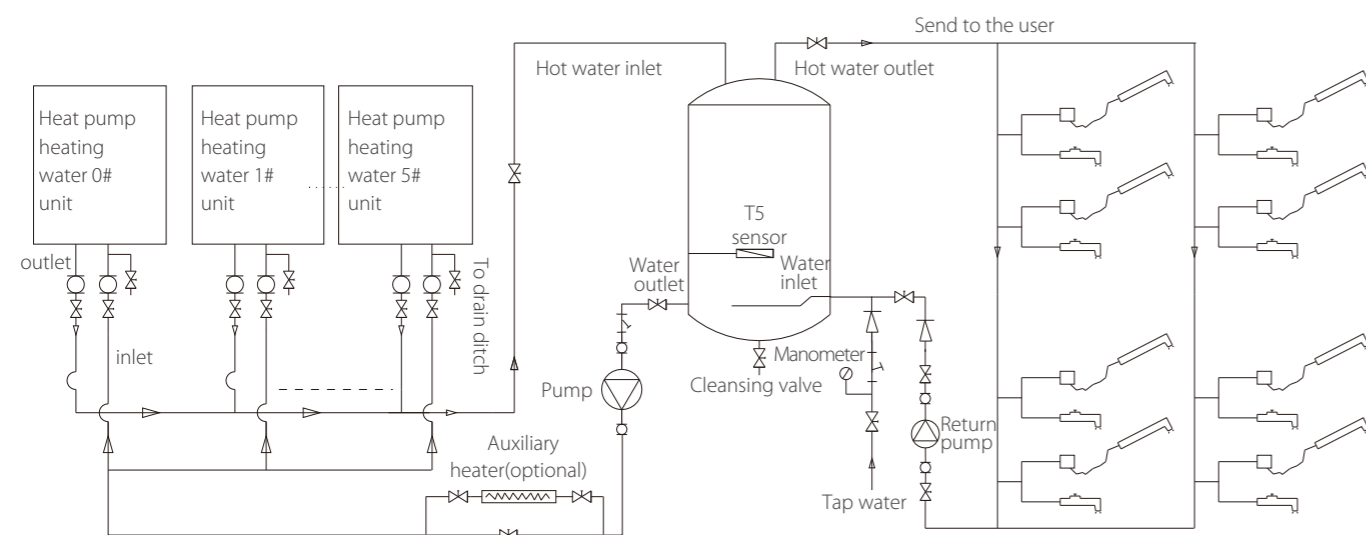

Single connected heat pump system

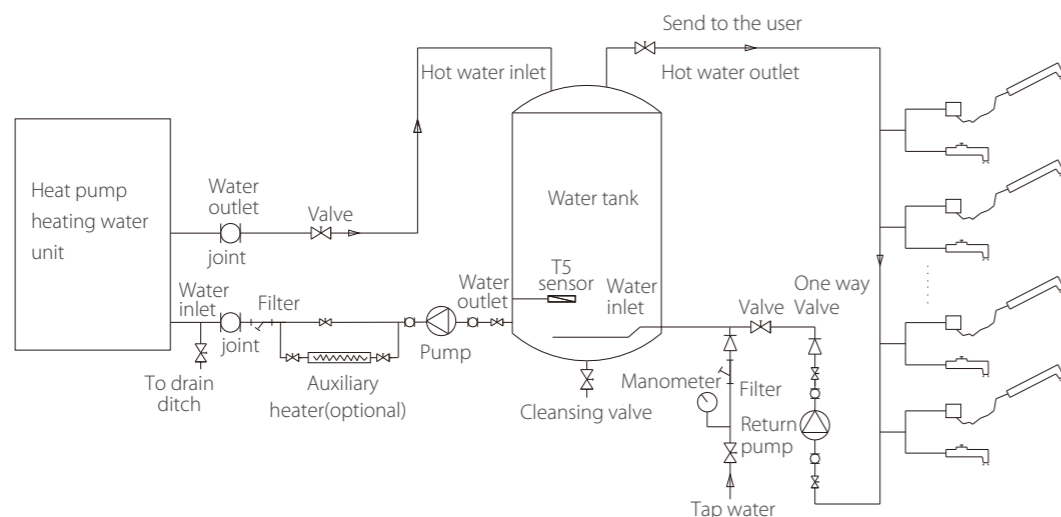

Specifications

Model			RSJ-120/ZN1-540V1	RSJ-200/SZN1-540V1
Power supply		V/Ph/Hz	220-240/1/50	380-415/3 / 50
Running ambient temp		°C	-15~46	-15~46
Outwater Temp		°C	Default 56°C, 48°C~60°C	
Water Heating	Capacity	kW	11.8	20.4
	Input	kW	2.95	5.23
	COP		4.00	3.90
	Max. input current	A	18.0	13.0
Unit dimension (WxHxD)		mm	790x1100x810	790x1100x810
Packing dimension (WxHxD)		mm	860x1220x885	860x1220x885
Net/Gross weight		kg	125/145	157/172
Outdoor noise level		dB(A)	59	63
Max. combination quantity		Pieces	6	6
Compressor	Type		Scroll	Scroll
	Quantity	Pieces	1	1
Fan motor	Type		AC motor	AC motor
	Quantity	Pieces	1	1
Air side heat exchanger		Type	Fin-coil	Fin-coil
Warer side heat exchanger		Type	Tube-in-tube	Tube-in-tube
Refrigerant	Refrigerant Type/Quantity	kg	R410A/1.55	R410A/2.9
	Throttle type		Electric expansion valve	
Water pipe	water inlet pipe	mm	DN25	DN25
	water outlet pipe	mm	DN25	DN25
Controller			KJR-51/BMKE-A	KJR-51/BMKE-A
Hot Water Yield ³		m ³ /h	0.25	0.45

Model			RSJ-420/SZN1-H	RSJ-800/SZN1-H
Power supply		V/Ph/Hz	380-415/3 / 50	380-415/3 / 50
Running ambient temp		°C	-15~46	-15~46
Outwater Temp		°C	Default 56°C, 48°C~60°C	
Water Heating	Capacity	kW	39.0	80.0
	Input	kW	9.65	20.00
	COP		4.04	4.00
	Max. input current	A	24.0	45.0
Unit dimension (WxHxD)		mm	1,015x1,775x1,026	1,995x1,770x1,025
Packing dimension (WxHxD)		mm	1,070x1,900x1,030	2,080x1,895x1,120
Net/Gross weight		kg	323/343	599/627
Outdoor noise level		dB(A)	66	68
Max. combination quantity		Pieces	4	2
Compressor	Type		Scroll	Scroll
	Quantity	Pieces	1	2
Fan motor	Type		AC motor	AC motor
	Quantity	Pieces	1	2
Air side heat exchanger		Type	Fin-coil	Fin-coil
Warer side heat exchanger		Type	Tube-in-tube	Tube-in-tube
Refrigerant	Refrigerant Type/Quantity	kg	R410A/4.5	R410A/2x4.4
	Throttle type		Electric expansion valve	
Water pipe	water inlet pipe	mm	DN32	DN50
	water outlet pipe	mm	DN32	DN50
Controller			KJR-51/BMKE-A	KJR-51/BMKE-A
Hot Water Yield ³		m ³ /h	0.85	1.72

- Remark:
1. The test conditions: outdoor temperature 20/15°C(DB/WB), inlet water temperature 15°C, outlet water temperature 55°C.
 2. The specifications may be changed for product improvement, please refer to the nameplate.
 3. The value is calculated based on the capability value and capability test condition.